



# scheurich

OUTDOOR 2025/26



**NEW!**

## MY POT. MY STYLE.



**COZY  
TERRACE**

**MODERN  
PATIO**

**SMART  
WATERING**



#SUSTAINABILITY

HELLO  
PLANT  
LOVERS,

WE ARE HERE  
FOR YOU!





Die Welt dreht sich schnell – wir gehen das Tempo mit, sind flexibel im Denken und treffen gleichzeitig gut überlegte Entscheidungen. Wir schaffen das, in dem wir uns auf **unsere Werte** fokussieren:

Wir stehen zu unserer Produktion **Made in Germany**. Seit Jahrzehnten stellen wir hochwertige Kunststoff-Pflanzgefäße her und nutzen dafür unsere **energieeffizienten und innovativen, zum Teil sogar patentierten Verfahren**.

Dank **modernster Logistiksoftware** garantieren wir **höchste Lieferquoten** und liefern unsere Ware ohne Verzögerungen zu unseren Kunden **in über 80 Ländern**.

Wir produzieren unsere hochwertigen Kunststoff-Pflanzgefäße zu **100% recyclingfähig**; unsere Kunststoffe haben einen **bis zu 100%igen Recyclingmaterial-Anteil** und wir geben **bis zu 10 Jahre Garantie darauf**. Damit sind unsere Pflanzgefäße anderen Lightweight-Produkten in punkto Nachhaltigkeit um Längen voraus.

**Bis 2035 werden wir klimaneutral in unseren Werken sein** – und weiterhin auf innovative Ideen setzen, wie zuletzt unser **PolyTech Verfahren**, das dreidimensional wirkende Dekore auf unsere Purista Gefäße bringt.

Ganz gleich, wie schnell die Welt sich weiterdreht: Auf unsere **innovativen Ideen**, unsere **hochwertigen Produkte** und auf **unsere Werte** können Sie sich jetzt und in Zukunft verlassen.

**We are here for you and you can rely on us!**

*The world is moving fast - we keep up with the pace, are flexible in our thinking and at the same time make well-considered decisions. We achieve this by focussing on **our values**:*

*We stand by our **Made in Germany** production. We have been producing high-quality plastic planters for decades, utilising our **energy-efficient and innovative processes, some of which are even patented**.*

*Thanks to **state-of-the-art logistics software**, we guarantee the **highest delivery rates** and deliver our goods to our customers **in over 80 countries** without delay.*

*We produce our high-quality plastic planters to be **100% recyclable**; our plastics contain **up to 100% recycled material** and are **guaranteed for up to 10 years**. This puts our planters streets ahead of other lightweight products in terms of sustainability.*

*We will be **climate-neutral in our factories by 2035** - and will continue to focus on innovative ideas, such as our **PolyTech process**, which brings three-dimensional decorations to our Purista planters.*

*No matter how fast the world keeps turning: you can rely on our **innovative ideas**, our **high-quality products** and **our values** now and in the future. **We are here for you and you can rely on us!***

**BJÖRN HANSEN**

Geschäftsführer · Managing Director

**RALF SCHWINN**

Geschäftsführer · Managing Director

**MARCUS GROTHAUS**

Geschäftsführer · Managing Director

# MY POT. MY STYLE(S).

Wir sind draußen zu Hause! Natürlich gemütlich, ganz im Sinne von Cozy Terrace, modern und klar, wie bei Modern Patio – und mit frischem Wasser gut versorgt bei Smart Watering. Alle Wohnstile und Produktarten präsentieren sich in 100 % recycelbaren Gefäßen, die Ihren Kundinnen und Kunden und auch den Pflanzen gefallen.

**Willkommen in der Welt von Scheurich!**

*The outdoor living room! Naturally cosy, in the spirit of Cozy Terrace, modern and clean, as with Modern Patio and plants are well refreshed and healthy thanks to Smart Watering. All home styles and product types are presented in 100% recyclable planters that will please both your customers and the plants.*

**Welcome to the world of Scheurich!**



**N°1** COZY  
TERRACE

**N°2** MODERN  
PATIO



**WE ARE ALL PART  
OF A SUSTAINABLE  
FUTURE.  
JOIN US!**

**TAKE  
3**



**N°3 SMART  
WATERING**

<b>SHAPES AND COLOURS</b>	<b>006</b>
<b>COMPANY FACTS</b>	<b>008</b>
<b>TRUSTED BRAND</b>	<b>010</b>
<b>DESIGN STORY</b>	<b>012</b>
<b>SUSTAINABILITY</b>	<b>014</b>
<b>GARDURO®</b>	<b>017</b>
<b>CERTURO®</b>	<b>018</b>
<b>REDURO®</b>	<b>019</b>
<b>INNOVATIVE PRODUCTION</b>	<b>020</b>
<b>COZY TERRACE</b>	<b>022</b>
<b>MODERN PATIO</b>	<b>042</b>
<b>SMART WATERING</b>	<b>068</b>
<b>SAUCER ROTATION</b>	<b>076</b>
<b>SAUCER INJECTION</b>	<b>078</b>
<b>ON REQUEST</b>	<b>080</b>
<b>POINT OF SALE</b>	<b>084</b>
<b>SOCIAL MEDIA</b>	<b>092</b>
<b>READY TO ORDER</b>	<b>094</b>
<b>LEGENDE KEY</b>	<b>120</b>

ROTATION | ROTATIONAL MOULDING



**riva**®

RIVA®



95



STONY GREY SCHWARZ-GRANIT

RIVA® HIGH



134

95



STONY GREY SCHWARZ-GRANIT

**c-cone**®

C-CONE®



96



STONY GREY STONY BLACK

C-CONE® BOWL



239

96



STONY GREY STONY BLACK

**c-cube**®

C-CUBE®



97



STONY GREY STONY BLACK

C-CUBE® HIGH



240

97

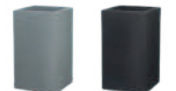

STONY GREY STONY BLACK

C-CUBE® LONG



97



STONY GREY



STONY BLACK

**coneo**®

CONEO®



98



SCHWARZ-GRANIT

CONEO® HIGH



243

98



SCHWARZ-GRANIT

**muretto**®

MURETTO®



99

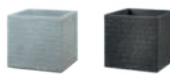

STONY GREY STONY BLACK

MURETTO® HIGH



247

99

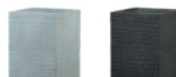

STONY GREY STONY BLACK

**wave globe**®

WAVE GLOBE®



100

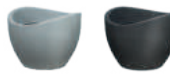

STONY GREY SCHWARZ-GRANIT

WAVE GLOBE® BOWL



252

100

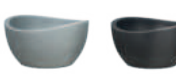

STONY GREY SCHWARZ-GRANIT

WAVE GLOBE® JARDINIERE



100



STONY GREY SCHWARZ-GRANIT

**wave globe**®

WAVE GLOBE® HIGH



101



STONY GREY SCHWARZ-GRANIT

WAVE GLOBE® CUBO



101



SCHWARZ-GRANIT

**Linetto**®

LINETTO®



102



STONY GREY STONY BLACK

LINETTO® HIGH



102



STONY GREY STONY BLACK

**flow**®

FLOW®



103



STONY GREY



STONY BLACK

**lineo**®

LINEO®



103



SCHWARZ-GRANIT

LINEO® HIGH



103



SCHWARZ-GRANIT

**barceo**®

BARCEO®



104



STONY GREY STONY BLACK

BARCEO® BOWL



104



STONY GREY STONY BLACK

BARCEO® JARDINIERE



105



STONY GREY



STONY BLACK

BARCEO® HIGH



105



STONY GREY STONY BLACK

**MARCELLA**®



106-107



STONY GREY



SCHWARZ-GRANIT



TERRA

# SPRITZGUSS | INJECTION MOULDING

## country star®

### COUNTRY STAR®



### COUNTRY STAR® HANGER



### COUNTRY STAR® BOWL



### COUNTRY STAR® JARDINIÈRE



## stones®

### STONES®



### STONES® SQUARE



### OLIVER®



### NORA®



### JESSICA®



### LARA®



### LINDA®



## SMART WATERING

MULTI-KOMPONENTEN-VERFAHREN.  
MULTI-COMPONENT-PROCESS. 

## purista+

### PURISTA+



## groove+

### GROOVE+



## SMART WATERING ACCESSOIRES | ACCESSORIES

### BÖRDY® XL



### BÖRDY® XXL



### COPA® XXL



# COMPANY FACTS.

Als Marktführer bei Pflanzgefäßen im In- und Outdoorbereich und als Mitglied der Scheurich-Group stehen wir für Qualität, Zuverlässigkeit und moderne, nachhaltig produzierte Produkte. Mit Scheurich, Formwerk und Soendgen profitieren Sie von **250 Jahren Erfahrung und Know-how** in der Branche.

*As the market leader for indoor and outdoor planters and a member of Scheurich-Group, we stand for quality, reliability and modern, sustainably produced products. With Scheurich, Formwerk and Soendgen, you benefit from **250 years of experience and know-how** in the industry.*

**SUSTAINABLE  
PRODUCTS AND  
PRODUCTION.**

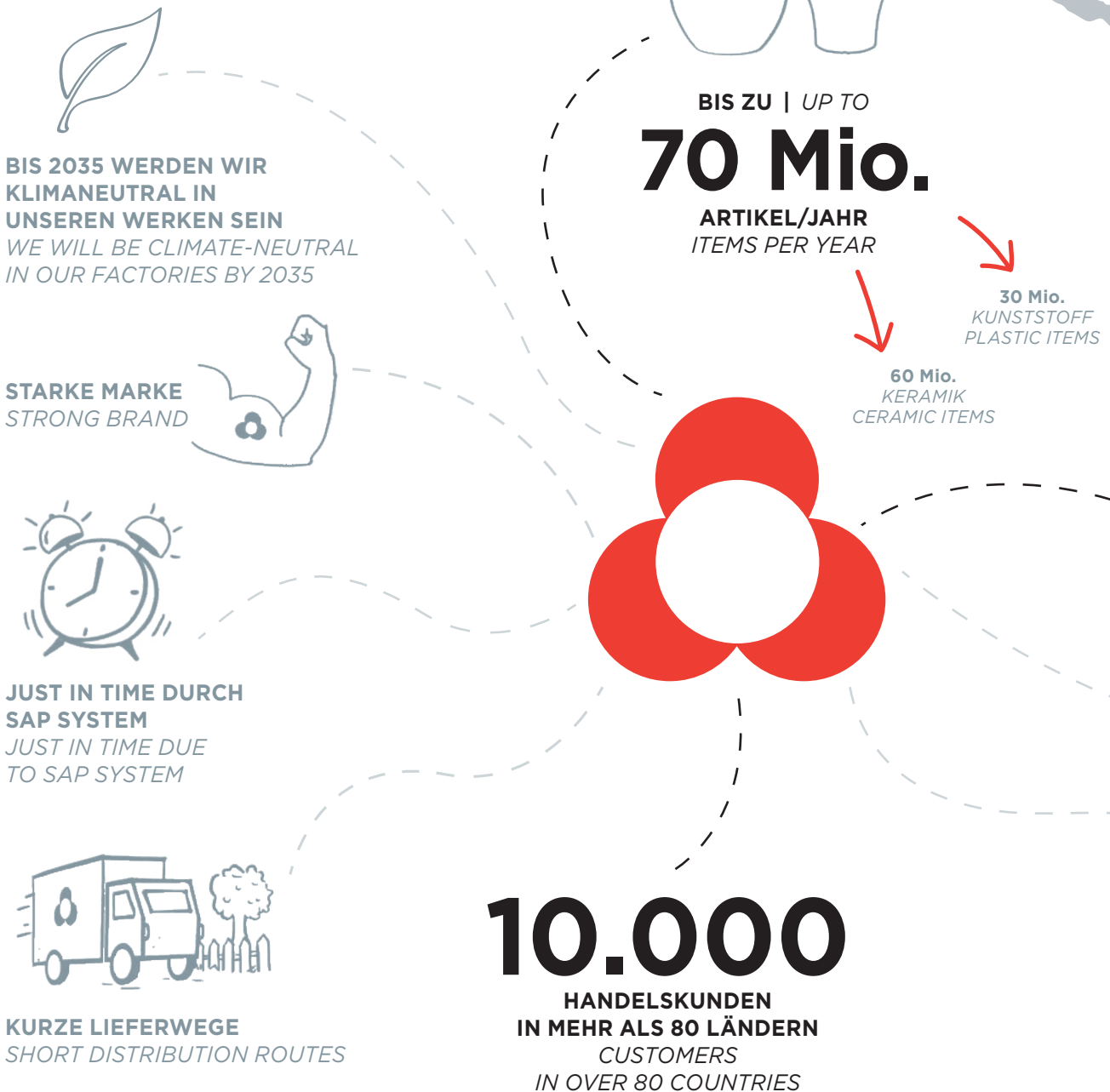





**VON DEUTSCHLAND IN DIE GANZE WELT**  
**FROM GERMANY DISTRIBUTED AROUND THE WORLD**

- 1 Scheurich Indoor factory Kleinheubach/Main
- 2 Formwerk Outdoor factory Neukirchen/Pl.
- 3 Soendgen Keramik factories Gelsdorf + Adendorf
- Scheurich Sales Offices



IN | AVAILABLE IN

**80**

LÄNDERN WELTWEIT VERTRETEN  
 COUNTRIES WORLDWIDE

SCHEURICH WORLD · COMPANY FACTS

**Scheurich-Group**

DREI FAMILIENUNTERNEHMEN MIT MEHR ALS  
 THREE FAMILY BUSINESSES WITH MORE THAN

**250**

JAHREN ERFAHRUNG  
 YEARS OF EXPERIENCE

**700**  
 MITARBEITENDE  
 EMPLOYEES



350  
 IN KLEINHEUBACH

120  
 IN NEUKIRCHEN

230  
 IN GELSDORF / ADENDORF

# FAMILY BUSINESS

**Vor über 90 Jahren** als Glas- und Porzellan-Großhandel gegründet, hat sich das Familienunternehmen immer wieder neu erfunden und zukunftsweisende Entscheidungen getroffen. **Als Mitglied der Scheurich-Group** bieten wir das stärkste Angebot an stilvollen Produkten für Blumen und Pflanzen für unsere Kundinnen und Kunden überall auf der Welt.

***Founded over 90 years ago** as a glass and porcelain wholesaler, the family business has continued to reinvent itself and make forward-looking decisions. **As member of the Scheurich-Group**, we offer you the world's strongest range of stylish products for flowers and plants.*



1928  
Die Gründer / the founders

Gründung eines Glas- und Porzellan-Großhandels  
*Founding of a glass and porcelain wholesale enterprise*

1928

1930

1950

1954



1954  
Kleinheubach/M.

Start der eigenen Keramikproduktion in Kleinheubach/M.  
*Launch of our first in-house production of ceramics in Kleinheubach/M.*

1970

1990

Einführung SAP: als einer der ersten Mittelständler setzt Scheurich auf das SAP-System  
*Introduction of SAP: Scheurich is one of the first medium-sized companies to use the SAP system*

2000

Gründung der Scheurich Inc. in den USA  
*Founding of Scheurich Inc. in the USA*

2005



# TRUSTED BRAND



**Scheurich ist bei Pflanzgefäßen seit Jahren die mit Abstand bekannteste Marke.** Die klare Kundenorientierung, die stringente Markenkommunikation sowie das moderne, trendorientierte Design tragen maßgeblich dazu bei. **So steht die Marke Scheurich für Vertrauen, Qualität, Bodenständigkeit und Innovation – Made in Germany.**

***Scheurich has been by far the best-known brand for planters for years.** A clear customer focus, a stringent brand communication and contemporary designs add up to a strong set of values. **Scheurich is a brand that means trust, quality, down-to-earthness and innovation – Made in Germany.***

  
scheurich





# Scheurich-Group



formwerk



Am 01. Januar schließen sich Scheurich, Soendgen und Formwerk zur Scheurich-Group zusammen

Aus dem neuen nachhaltigen Kunststoff CERTURO® werden Gefäße im Multi-Komponenten-Verfahren hergestellt

*On 01 January Scheurich, Soendgen and Formwerk merged into the Scheurich-Group*

*From the new sustainable plastic CERTURO® we produce planters using a multi-component process*

Scheurich startet mit PolyTech ein weiteres zukunftsweisendes Dekorationsverfahren

*With PolyTech decorating Scheurich developed another futuristic process.*

2010

2012

Start der eigenen Kunststoffproduktion im Scheurich Formwerk (vormals PP-PLASTIC) in Neukirchen/Pl.

*Launch of our own plastic items production at Scheurich Formwerk (formerly PP-Plastic) in Neukirchen/Pl.*

2018

Scheurich startet mit PolyPrint das Produktionsverfahren der Zukunft

*With PolyPrint Scheurich launches the manufacturing technique of the future*

2020

2021

2022

# DESIGN STORY

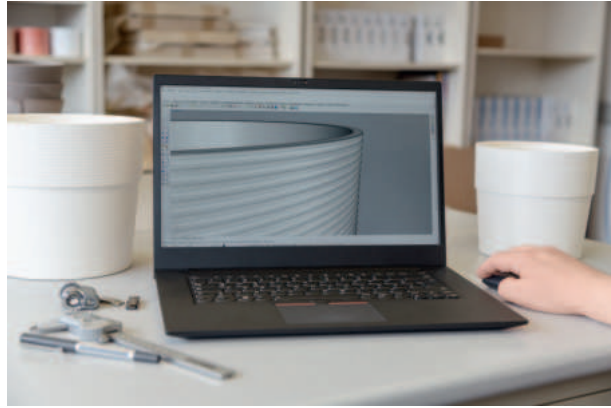

## VON DER IDEE ZUM ERFOLGREICHEN PFLANZGEFÄSS

### FROM THE IDEA TO THE SUCCESSFUL PLANTER

#### Was macht ein vielversprechendes Pflanzgefäß aus?

Nachhaltig muss es sein, praktisch auch und gut aussehen sowieso. Unser Designteam beschäftigt sich intensiv mit den Anforderungen und überträgt sie mithilfe modernster 3D-Technik in die Wirklichkeit. So überzeugt unsere **Neuheit GROOVE+** aus unserem innovativen und **recyclbaren CERTURO® Kunststoff** nachhaltig mit Wertigkeit und modernem Design.

*What is a good planter? It has to be sustainable, practical and good to look at. Our design team takes a close look at the requirements and translates them into reality with the help of the latest 3D technology. This is how our **new GROOVE+** made of our innovative and **recyclable CERTURO® plastic** convinces with lasting value and modern design.*



## WE CREATE YOUR **SUCCESS**

Wie erfolgreich „Indoor goes Outdoor“ sein kann, beweist **LINETTO®**: Vorbild ist unser hervorragend verkaufter Keramik Blumentopf Solido Linea - sein moderner, wie **hand-gemachter Look** sowie seine **dickwandige Beschaffenheit** überzeugen jetzt auch Outdoor-Fans.

***LINETTO®** proves how successful “indoor goes outdoor” can be: the model is our excellent-selling ceramic flower pot Solido Linea - its modern, **handmade look** and **thick-walled structure** are now available for outdoor lovers as well.*



# SUSTAINABILITY CONCEPT

## GUT ODER BÖSE? WIE WIR ZU KUNSTSTOFF STEHEN

In vielen Bereichen des täglichen Lebens ist er unverzichtbar – gleichzeitig ist er aktuell umstritten: Kunststoff. Doch wir finden, dass pauschale Urteile nicht helfen. Vielmehr wollen wir alles dafür tun, **Kunststoff sinnvoll** zu **verarbeiten**, im Sinne **langlebiger**, **recyclingfähiger** und **nachhaltiger Produkte**.

## GOOD OR BAD? HOW WE RELATE TO PLASTIC

*It is indispensable in many areas of daily life – at the same time it is currently controversial. But we believe that broadstroke statements don't help anyone. Instead, we want to do everything we can to **process plastic sensibly**, in the sense of **durable, recyclable and sustainable products**.*

WATCH  
THE VIDEO!



WAS WIR HEUTE TUN,  
entscheidet darüber,  
wie die Welt morgen aussieht.

WHAT WE DO TODAY DECIDES  
WHAT THE WORLD WILL LOOK LIKE  
TOMORROW.



## 5 FAKTEN ÜBER NACHHALTIGKEIT

### 5 FACTS ABOUT SUSTAINABILITY



- 1 Wir sind Pioniere umweltfreundlicher Produktion. Seit Jahren sind wir **ÖKOPROFIT- und ISO-zertifiziert**.

*We are pioneers of environmentally friendly production: we have been **ECOPROFIT and ISO certified** for years.*

- 2 Alle unsere Kunststoff-Pflanzgefäße sind **UV- und frostbeständig** und dadurch **besonders langlebig** sowie zu **100% recyclingfähig**.

*All our plastic planters are **UV and frost resistant**, making them **extra durable** and **100% recyclable**.*

- 3 **Made in Germany:** Hohe Qualität, kurze Lieferwege, sichere Arbeitsplätze.

***Made in Germany:** high quality, short delivery routes, secure jobs.*

- 4 **Nachhaltigkeit** bedeutet für uns nur so viel Verpackung wie nötig zu verwenden und keine Energie zu verschwenden. Möglich dank eigener **Photovoltaik-Anlage** und **Wärme-Rückgewinnung**.

***Sustainability** for us means using as little packaging as possible and not wasting any energy. This we can do thanks our own **photovoltaic** and **heat recovery systems**.*

- 5 **Unser Beitrag für die Welt von morgen**  
**Our contribution to tomorrow's world**

Wir werden bis 2035  
**KLIMANEUTRAL**  
in unseren Werken sein!

WE WILL BE  
**CLIMATE-NEUTRAL**  
IN OUR FACTORIES BY 2035!



## BUY LESS, CHOOSE WELL, MAKE IT LAST!



Alle unsere Gefäße, Schalen und Untersetzer sind **UV- und frostfest**, um möglichst lange schön und stabil zu sein



All our planters, bowls and saucers are **UV and frost resistant** to be beautiful and stable for as long as possible



Ein hoher bis vollständiger Anteil an **Recyclingmaterial** macht unsere Pflanzgefäße zu modernen, nachhaltigen und **vollständig recyclingfähigen** Leichtgewichten



A high to complete share of **recycled material** makes our planters modern, sustainable and **fully recyclable** lightweights



Scheurich ist die Marke Nr. 1 bei Pflanzgefäßen „**Made in Germany**“

*Scheurich is the No. 1 brand for planters "Made in Germany"*





# GARDURO®.

## DURABLE & SUSTAINABLE.

### 10 JAHRE GARANTIE

**GARDURO® ist unser hochwertiger, recyclingfähiger Kunststoff**, aus dem wir im verlustfreien, patentierten Kugelrotationsguss-Verfahren besonders langlebige Pflanzgefäße herstellen. Unsere hohen Qualitätsstandards über den gesamten Produktionskreislauf machen es möglich.

**LANGLEBIG. NACHHALTIG.  
MIT 10 JAHREN GARANTIE.  
PFLANZGEFÄSSE AUS GARDURO®.**

### 10 YEARS GUARANTEE

**GARDURO® is our high-quality, recyclable plastic** from which we produce particularly durable planters using the loss-free, patented ball rotational moulding process. Our high quality standards over the entire production cycle make this possible.

**DURABLE. SUSTAINABLE.  
WITH A 10 YEARS GUARANTEE.  
PLANTERS MADE OF GARDURO®.**



# CERTURO®.

## SOLID & SUSTAINABLE.

### 8 JAHRE GARANTIE

**CERTURO® ist unser recyclingfähiger Kunststoff**, aus dem wir Pflanzgefäße von hoher Wertigkeit und mit hohem Recyclingmaterial-Anteil in einem innovativen Multi-Komponenten-Verfahren fertigen. Die Eigenschaften von **CERTURO®** ermöglichen die Gestaltung besonders wertiger, natürlicher Oberflächen verschiedener Stil- und Designrichtungen.

**LANGLEBIG. NACHHALTIG.  
MIT 8 JAHREN GARANTIE.  
PFLANZGEFÄSSE AUS CERTURO®.**

### 8 YEARS GUARANTEE

**CERTURO® is our recyclable plastic material**, from which we produce plant pots of high quality. A high proportion of recycled material is used in an multi-component production process. The **CERTURO® elements** help create a pleasing product with natural surfaces, different styles and design directions.

**DURABLE. SUSTAINABLE.  
WITH A 8 YEARS GUARANTEE.  
PLANTERS MADE OF CERTURO®.**



# REDURO®. RECYCLED & RECYCLABLE.

## 3 JAHRE GARANTIE

REDURO® ist unser 100% Recyclingkunststoff. Daraus fertigen wir im Spritzguss-Verfahren unter anderem unsere Pflanzgefäß-Serien Country Star® und Stones®.

**100% RECYCLED UND RECYCLINGFÄHIG. MIT 3 JAHREN GARANTIE. PFLANZGEFÄSSE AUS REDURO®.**  
*REDURO® is our 100% recycled plastic.*

## 3 YEARS GUARANTEE

We use it for the injection moulding process to produce, among other things, our series of planters Country Star® and Stones®.

**100% RECYCLED AND RECYCLABLE. WITH A 3 YEARS GUARANTEE. PLANTERS MADE OF REDURO®.**



SCHEURICH WORLD · CERTURO® · REDURO® | GUARANTEE



Scheurich Pflanzgefäße bestehen aktuell aus ca. 70 % Recyclingmaterial, einzelne Serien sogar aus unserem 100 % Recyclingkunststoff REDURO®. **So wollen wir unsere Recyclingmaterial-Quote in der Kunststoff-Produktion in den nächsten drei Jahren auf über 80 % erhöhen.**

Scheurich planters are currently made of approx. 70% recycled material, some series are even made of our 100% recycled plastic REDURO®. **With this we want to increase our recycled material quota in plastics production to over 80% in the next three years.**



# INNOVATIVE PRODUCTION

**Am Produktionsstandort Neukirchen/Pleiße** produzieren aktuell 7 Rotations- und 25 Spritzgussmaschinen im Ein- und Mehrkomponentenverfahren unsere Qualitätsprodukte für den Outdoorbereich. **Hier entstehen bis zu 80.000 Artikel am Tag.**

*At our production site in Neukirchen/Pleiße, 7 rotational and 25 injection moulding machines using single and multi component process currently produce our quality products for the outdoor sector. **Up to 80,000 articles are produced here per day.***



**1 hour**  
production time  
inclusive hand finishing

**1 piece**

**rotational  
moulding**

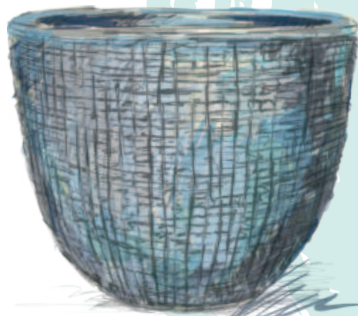

WATCH  
THE VIDEO!



Das größte im Werk produzierte Spritzguss-Gefäß hat einen Durchmesser von 80 cm und fasst 150 Liter Inhalt.

The largest injection moulding planter produced in the factory is with a diameter of 80 cm and has a capacity of 150 litres.

NICE TO KNOW!



1 hour production time

25 pieces

multi component process



1 hour production time

100 pieces

injection moulding

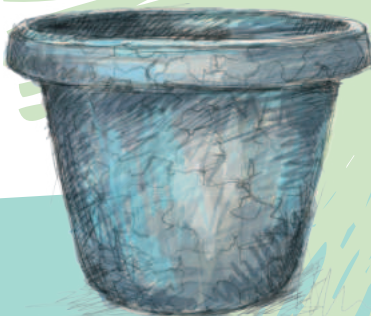

WATCH THE VIDEO!







OUTDOOR STYLE N°1 · COZY TERRACE

# COZY TERRACE



GEERDET · NATÜRLICH · AUTHENTISCH · GEMÜTLICH  
GROUNDED · NATURAL · AUTHENTIC · COZY

# COZY TERRACE.

## MURETTO®

### IMPRESSIVE STONE-WALL-LOOK.

Mit seinem **einzigartigen Look der an schönes, altes Mauerwerk erinnert**, verbreitet **MURETTO®** gemütlichen Retro-Charme in den Outdoor-Bereich.

*With its **unique look reminiscent of beautiful old brickwork**, **MURETTO®** spreads cosy retro charm into the outdoor area.*

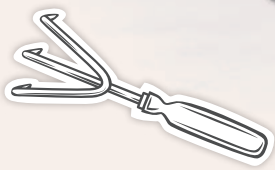

● STONY BLACK

● STONY GREY

①

**247 MURETTO® HIGH**  
**STONY GREY**  
SIZE 60  
» PAGE 99

② + ③

**246 MURETTO®**  
**STONY BLACK**  
SIZE 30, 40  
» PAGE 99



# muretto®

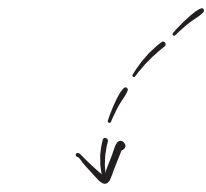

COZY TERRACE · MURETTO®

Mit Verschluss  
With plug

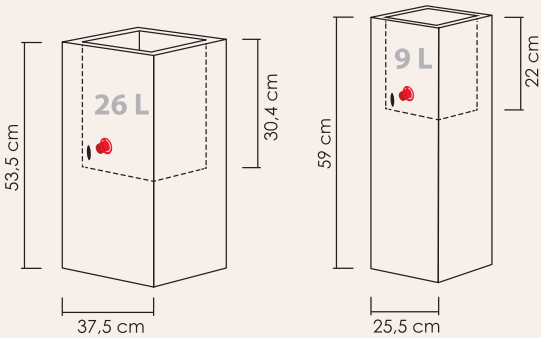

④ + ⑥  
**246 MURETTO®**  
 STONY GREY  
 SIZE 30, 40  
 » PAGE 99

⑤  
**247 MURETTO® HIGH**  
 STONY BLACK  
 SIZE 54  
 » PAGE 99

# COZY TERRACE. BARCEO® INSPIRES NATURALLY.

**Natürlich schöne Strukturen**, wie die von Baumrinde, bilden die Basis für Barceo®, unserer Outdoor-Gefäß Serie mit dem besonderen Finish.

***Naturally beautiful structures** such as tree bark form the basis for Barceo®, our outdoor planter series with that special finish.*

barceo®



**Mit Verschluss**  
*With plug*

● STONY BLACK

● STONY GREY

**LEONARDO DA VINCI**

hat vor 500 Jahren als erster erkannt, dass die Baumringe mit dem Alter des Baumes zusammenhängen.

**LEONARDO DA VINCI**

was the first to recognize 500 years ago that tree rings are related to the age of the tree.



NICE TO KNOW!



①



②

①



①

**295 BARCEO®**  
STONY BLACK  
SIZE 30, 40, 47  
» PAGE 104

②

**295 BARCEO®**  
STONY GREY  
SIZE 30, 40, 47  
» PAGE 104

Passende Untersetzer siehe Seite 76/77 · Matching saucers see page 76/77



}  
**LIGHTWEIGHT**  
 &  
**LOVELY**



①



②



**PERFECT FOR**  
**CONTAINER**  
**GARDENING**

①

**297 BARCEO® BOWL**  
**STONY BLACK**  
 SIZE 40  
 » PAGE 105

②

**298 BARCEO® JARDINIERE (OVAL)**  
**STONY GREY**  
 SIZE 60  
 » PAGE 105



# COZY TERRACE. BARCEO® HIGH.

## barceo®



4

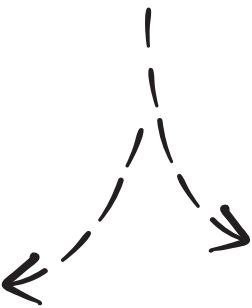

3



Mit Verschluss  
With plug

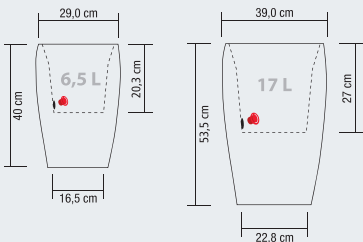

3

**299 BARCEO® HIGH**  
STONY BLACK  
SIZE 40, 54  
» PAGE 105

4

**299 BARCEO® HIGH**  
STONY GREY  
SIZE 40, 54  
» PAGE 105

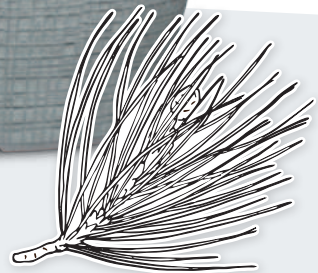

● STONY BLACK

● STONY GREY

COZY TERRACE · BARCEO®

lineo®



10  
YEARS  
GUARANTEE  
GARDURO®

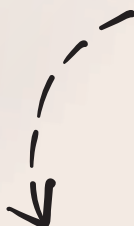

Passende Untersetzer siehe Seite 76/77  
Matching saucers see page 76/77



①

**282 LINEO®**  
SCHWARZ-GRANIT  
SIZE 30, 40, 48  
» PAGE 103



# COZY TERRACE. OUR LINEO® LINE-UP.

COZY TERRACE · LINEO®



2



Mit Verschluss  
With plug

SCHWARZ-GRANIT

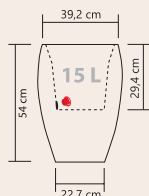
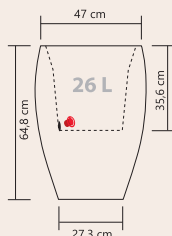

2

**283** LINEO® HIGH  
SCHWARZ-GRANIT  
SIZE 54, 65  
» PAGE 103



# COZY TERRACE.

## CONEO® MODERN CLASSIC.



①

**242 CONEO®**  
**SCHWARZ-GRANIT**  
 SIZE 30, 40, 49  
 » PAGE 98

● SCHWARZ-GRANIT



● Mit Verschluss  
 With plug

Passende Untersetzer siehe Seite 76/77 · Matching saucers see page 76/77



## NATURAL LOOK IN MODERN SHAPE

Das Pflanzgefäß Coneo® überzeugt durch sein modernes, natürliches Design kombiniert mit einer charaktvollen Oberfläche.

*The planter Coneo® combines modern design with a natural surface.*

**coneo®**

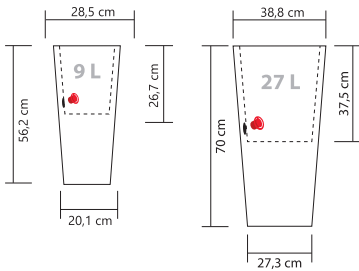
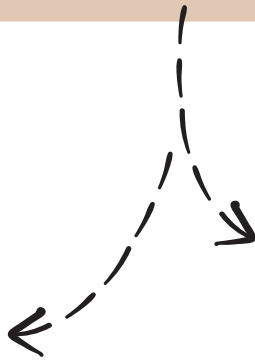

COZY TERRACE · CONEO®

②

**243 CONEO® HIGH SCHWARZ-GRANIT**  
 SIZE 55, 70  
 » PAGE 98





## CLEVER GEMACHT:

Unsere Spritzguss-Gefäße verfügen über Wasserabflöcher UND über ein Mini-Wasserreservoir im Topfboden. Siehe Skizze!

## CLEVERLY MADE:

Our injection-moulded planters have water drainage holes AND a mini water reservoir in the bottom of the pot. See sketch!

# country star<sup>®</sup>



②

①

①

**270 COUNTRY STAR<sup>®</sup>**  
METALLIC GREY  
SIZE 25, 30, 35, 40, 48  
» PAGE 111

②

**270 COUNTRY STAR<sup>®</sup>**  
GRANITE GREY  
SIZE 25, 30, 35, 40, 48  
» PAGE 111

● METALLIC GREY

● GRANITE GREY

● TERRACOTTA

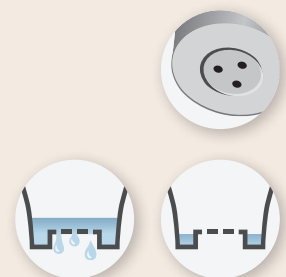

# COZY TERRACE. NATURAL BEAUTY.

Der Country Star® besticht durch seine **einzigartige, natürliche Oberfläche** und eine breite Krempe. Durch diese lassen sich die Gefäße auch bepflanzt gut transportieren.

*Country Star® starts with its **unique, natural surface** and a **broad rim**. The planters are easy to carry when planted.*



③  
**270 COUNTRY STAR®**  
METALLIC GREY  
SIZE 25, 30, 35, 40, 48  
» PAGE 111

④  
**270 COUNTRY STAR®**  
TERRACOTTA  
SIZE 25, 30, 35, 40, 48  
» PAGE 111

⑤  
**270 COUNTRY STAR®**  
GRANITE GREY  
SIZE 25, 30, 35, 40, 48  
» PAGE 111

NICE TO  
KNOW!



### OUTDOOR & INDOOR

Ohne Ablaufloch auch für  
den Wohnbereich geeignet.

*Without drain hole,  
also suitable for indoor use.*



①

②

## country star®

①

**277 COUNTRY STAR®**  
JARDINIÈRE  
TERRACOTTA  
SIZE 49  
» PAGE 112

②

**277 COUNTRY STAR®**  
JARDINIÈRE  
METALLIC GREY  
SIZE 49  
» PAGE 112

③

**271 COUNTRY STAR®**  
HANGER  
METALLIC GREY  
SIZE 25, 30  
» PAGE 111

④

**271 COUNTRY STAR®**  
HANGER  
TERRACOTTA  
SIZE 25, 30  
» PAGE 111

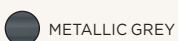

METALLIC GREY



GRANITE GREY



TERRACOTTA



3



4

# COZY TERRACE. MORE NATURAL BEAUTIES.



5



7



6

PERFECT FOR  
CONTAINER  
GARDENING

5  
**276 COUNTRY STAR®**  
BOWL  
GRANITE GREY  
SIZE 30, 40  
» PAGE 112

6  
**276 COUNTRY STAR®**  
BOWL  
TERRACOTTA  
SIZE 30, 40  
» PAGE 112

7  
**276 COUNTRY STAR®**  
BOWL  
METALLIC GREY  
SIZE 30, 40  
» PAGE 112

Passende Untersetzer siehe Seite 78 · Matching saucers see page 78

Weitere Informationen  
siehe Seite 19  
More information see  
page 19

COZY TERRACE · COUNTRY STAR®



# COZY TERRACE.

## OLIVER® TAKES IT EASY.

**Auf Oliver® schwören Garten-Neulinge und -Profis sowieso:** mit seiner breiten Krempe und dem unaufdringlichen Design passt er in viele Gärten und auf viele Terrassen und Balkone.

**Garden newcomers and professionals swear by Oliver® anyway:** with its wide brim and unobtrusive design it fits in many gardens and on many terraces and balconies.



①

**322 OLIVER®**  
METALLIC GREY

SIZE 20, 25, 30, 35, 40, 45, 50, 60, 70, 80  
» PAGE 114



①

②

**322 OLIVER®**  
TERRACOTTA

SIZE 20, 25, 30, 35, 40, 45, 50, 60, 70, 80  
» PAGE 114



②



● METALLIC GREY

● TERRACOTTA

DIE PERFEKTE  
PFLANZSCHALE  
für Einsteiger und  
erfahrene Gärtner

THE PERFECT  
PLANTING BOWL  
*for beginners and  
experienced gardeners*

# COZY TERRACE. PLANT IDEAS WITH JESSICA®.

**EASY-GOING &  
NATURAL LOOK**



③  
**340 JESSICA® BOWL**  
METALLIC GREY  
SIZE 20, 30, 35, 40, 50  
» PAGE 115



④  
**340 JESSICA® BOWL**  
TERRACOTTA  
SIZE 20, 30, 35, 40, 50  
» PAGE 115



COZY TERRACE · OLIVER® · JESSICA®



**Ohne Ablaufloch auch  
für den Wohnbereich geeignet.**  
Without drain hole,  
also suitable for indoor use.

**AUFREGEND UNAUFGEREGT:**

Nora® passt mit den abgerundeten Ecken und feinen Details auf der Oberfläche einfach in jeden Garten.

**EXCITINGLY UNAGITATED:**

Nora® fits easily into any garden with its rounded corners and fine details on the surface.



# COZY TERRACE. ALL YOU NEED IS NORA®.



①

**326 NORA®  
TERRACOTTA**

SIZE 14, 19, 23, 28, 33, 40, 48, 58  
» PAGE 114





②

②

**326 NORA®  
METALLIC GREY**

SIZE 14, 19, 23, 28, 33, 40, 48, 58  
» PAGE 114

 TERRACOTTA

 METALLIC GREY





COZY TERRACE · NORA®



**EXTREM  
VIELSEITIG**  
EXTREMELY  
VERSATILE





OUTDOOR STYLE N°2 · MODERN PATIO

# MODERN PATIO

KLAR · GERADLINIG · CHARAKTERVOLL · TRENDBEWUSST  
*CLEAN LINES · IMPOSING · STRONG · ON-TREND*

# MODERN PATIO. THE WAVE GLOBE® FAMILY.



## EIN ECHTER SCHEURICH KLASSIKER!

Wave Globe® von Scheurich steht für **elegantes Design und durchdachte Funktionalität - for you made in Germany**. Die Pflanzgefäß-Serie überzeugt durch ihre dickwandige Steinoptik und ist in vielen verschiedenen Varianten erhältlich.

## A TRUE SCHEURICH CLASSIC!

Wave Globe® from Scheurich stands for **elegant design and sophisticated functionality - for you made in Germany**. The planter series impresses with its thick-walled stone look and is available in many different versions.

## DESIGN MEETS FUNCTION:

DISCOVER MORE ON THE  
FOLLOWING PAGES!



# WAVE GLOBE. OUR PERFECT WAVES.

In Kombination mit Hochgefäßen schlägt unsere Wave Globe Serie hohe Wellen. Vor allem am Hauseingang, aber auch auf der Terrasse kommen sie elegant und dekorativ daher.

*Combined with high planters our Wave Globe series make big waves. Especially at the house entrance, but also on the terrace they look elegant and decorative.*

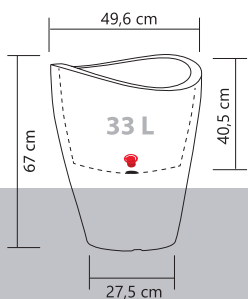
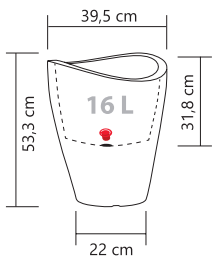
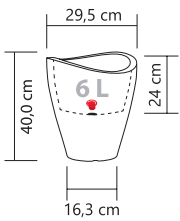

Mit Verschluss  
With plug



①

**254 WAVE GLOBE® HIGH**  
SCHWARZ-GRANIT  
SIZE 40, 54, 67  
» PAGE 101

● SCHWARZ-GRANIT

②

**254 WAVE GLOBE® HIGH**  
STONY GREY  
SIZE 40, 54, 67  
» PAGE 101

● STONY GREY

MODERN PATIO · WAVE GLOBE®

**wave globe®**



EINE LA-OLA-WELLE BRAUST MIT DURCHSCHNITTLICH 40 KM/H DURCH DAS STADIUM.

A LA OLA WAVE ROARS THROUGH THE STADIUM AT AN AVERAGE SPEED OF 40 KM/H.



CRAZY FACTS!

**wave globe®**



Mit Verschluss  
With plug



①  
**256 WAVE GLOBE® CUBO**  
SCHWARZ-GRANIT  
SIZE 40, 50  
» PAGE 101

②  
**250 WAVE GLOBE®**  
STONY GREY  
SIZE 30, 40, 50, 60  
» PAGE 100

③  
**250 WAVE GLOBE®**  
SCHWARZ-GRANIT  
SIZE 30, 40, 50, 60  
» PAGE 100

# MODERN PATIO. PERFECT WAVES FOR YOUR HOME.

Das typische Wellendesign macht alle Wave Globe® Gefäße von der Schale bis zur Jardiniere zu dekorativen Hinguckern auf Terrasse und Balkon, im Garten und am Hauseingang.

*The typical wave design makes all Wave Globe® planters, from bowls to jardiniere, decorative eye-catchers on the terrace and balcony, in the garden and at the house entrance.*

## DEKORATIVER HINGUCKER

A DECORATIVE  
EYE-CATCHER



MODERN PATIO · WAVE GLOBE®

④

**252** WAVE GLOBE® BOWL  
STONY GREY  
SIZE 40  
» PAGE 100

⑤

**253** WAVE GLOBE® JARDINIERE (OVAL)  
SCHWARZ-GRANIT  
SIZE 58  
» PAGE 100

● SCHWARZ-GRANIT

● STONY GREY

PERFECT FOR  
CONTAINER  
GARDENING



①  
**259 LINETTO®**  
 STONY GREY  
 SIZE 30, 40, 47  
 » PAGE 102



②  
**259 LINETTO®**  
 STONY BLACK  
 SIZE 30, 40, 47  
 » PAGE 102

● STONY GREY

● STONY BLACK

**Linetto®**



# MODERN PATIO. LINETTO® - ALL ALONG THE LINE.



Auf ganzer Linie natürlich, modern und gleichzeitig detailverliebt - dafür steht Linetto®, unsere Neuheit in Zylinderform mit vertikalen Rillen.

*Natural all along the line, modern and at the same time with a love of detail - that's what Linetto stands for,* our novelty with a love for detail in a soft cylindrical shape.



3

3  
**260 LINETTO® HIGH**  
STONY GREY  
SIZE 54  
» PAGE 102

4  
**260 LINETTO® HIGH**  
STONY BLACK  
SIZE 54  
» PAGE 102



Mit Verschluss  
With plug

MODERN PATIO · LINETTO®

Weitere Informationen siehe Seite 17  
More information see page 17

# MODERN PATIO. VIVA LA RIVA® LUTION

**riva**®

Im angesagten **Beton-Look** bringt das **Zylinder-Pflanzgefäß RIVA®** gute Laune auf die Terrasse, den Balkon und in den Garten.

*With its trendy **concrete look**, the **cylindric planter RIVA®** brings positive vibes to the terrace, balcony and garden.*

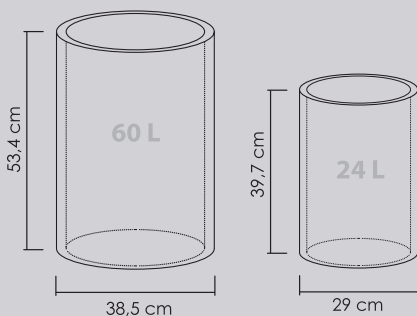

● STONY GREY

● SCHWARZ-GRANIT

①  
**130 RIVA®**  
STONY GREY  
SIZE 30, 40, 50  
» PAGE 95

②  
**130 RIVA®**  
SCHWARZ-GRANIT  
SIZE 30, 40, 50  
» PAGE 95

③  
**134 RIVA® HIGH**  
STONY GREY  
SIZE 40, 54  
» PAGE 95



MODERN PATIO · RIVA®

④

④

**130 RIVA®**  
**SCHWARZ-GRANIT**  
SIZE 30, 40, 50  
» PAGE 95

⑤

⑤

**134 RIVA® HIGH**  
**STONY GREY**  
SIZE 40, 54  
» PAGE 95

# MODERN PATIO.

MIT DEM PANTHEON IN ROM  
BEGANN DIE BETON-LUST,  
DIE BIS HEUTE ANHÄLT:

Unser C-Cone® überzeugt mit seinem  
authentischen Look und seiner Leichtigkeit.

THE PANTHEON WAS ONE OF THE FIRST  
CONCRETE LOOK TRENDSETTERS,  
AND THAT UP TO TODAY.

C-Cone® is equally convincing with its  
authentic look and lightweight feel.



**c-cone®**

①



②



③



①

**238 C-CONE®**  
STONY GREY  
SIZE 30, 40, 49  
» PAGE 96

②

**238 C-CONE®**  
STONY BLACK  
SIZE 30, 40, 49  
» PAGE 96

③

**238 C-CONE®**  
STONY GREY  
SIZE 30, 40, 49  
» PAGE 96

● STONY BLACK

● STONY GREY



Mit Verschluss  
With plug



**C = CONCRETE, THE  
TREND OF TODAY.**



④



⑤



④

**239 C-CONE® BOWL**  
STONY BLACK  
SIZE 40  
» PAGE 96

⑤

**239 C-CONE® BOWL**  
STONY GREY  
SIZE 40  
» PAGE 96

**PERFECT FOR  
CONTAINER  
GARDENING**

Passende Untersetzer siehe Seite 76/77 · Matching saucers see page 76/77

# MODERN PATIO. LET'S CUBE IT UP!



**Ein paar Ecken und Kanten stehen jeder modernen Terrasse und jedem Garten gut.** Und dank der vielfältigen Formen und Größen der Serie C-Cube® gibt es für jeden Bedarf die passenden Gefäße.

**A few nooks and crannies are good for any modern terrace and garden.** And thanks to the wide range of shapes and sizes in the C-Cube® series, there is a suitable planter for every need.



①

②

① + ③

**240 C-CUBE®**  
STONY BLACK  
SIZE 30, 40  
» PAGE 97

② + ④

**240 C-CUBE®**  
STONY GREY  
SIZE 30, 40  
» PAGE 97

⑤

**240/60 C-CUBE® LONG**  
STONY GREY  
SIZE 60  
» PAGE 97

⑥

**240/80 C-CUBE® LONG**  
STONY BLACK  
SIZE 80  
» PAGE 97



STONY BLACK



STONY GREY



# c-cube®

MODERN PATIO · C-CUBE®

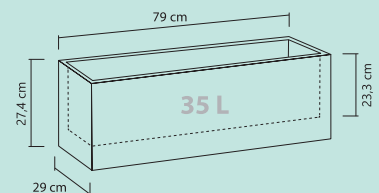
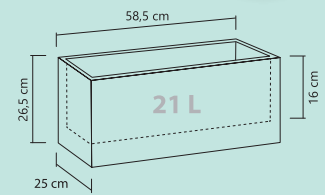

# MODERN PATIO. ON TOP OF THE CUBES.



①

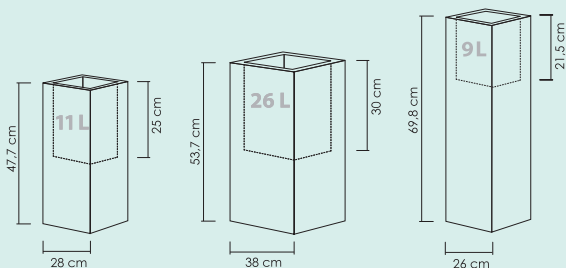

①

**240/70 C-CUBE® HIGH**  
**STONY BLACK**  
 SIZE 70  
 » PAGE 97



# c-cube®



MODERN PATIO · C-CUBE®

②  
**240/54 C-CUBE® HIGH**  
 STONY GREY  
 SIZE 54  
 » PAGE 97

③  
**240/48 C-CUBE® HIGH**  
 STONY BLACK  
 SIZE 48  
 » PAGE 97

④  
**240/70 C-CUBE® HIGH**  
 STONY GREY  
 SIZE 70  
 » PAGE 97

● STONY BLACK   ● STONY GREY

# MODERN PATIO. GO WITH OUR FLOW®!

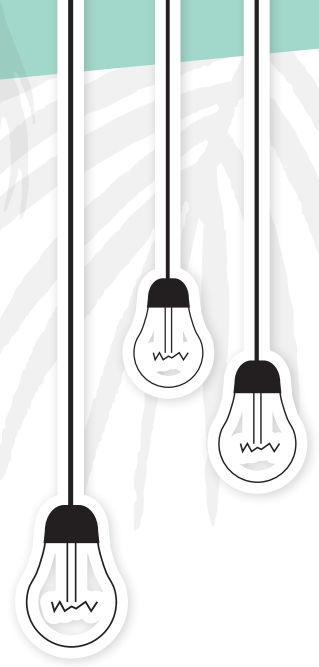

**ALLES  
FLIESST**

IN THE  
FLOW

**NICE TO  
KNOW!**

**TYPISCH FÜR ORGANISCHES DESIGN:**  
dynamische Rundungen und kraftvolle  
Wölbungen. That's why you can  
go with our Flow®!

**TYPICAL FOR ORGANIC DESIGN:**  
dynamic curves and powerful curvatures.  
That's why you can go with our Flow®!



**flow**®



1

2

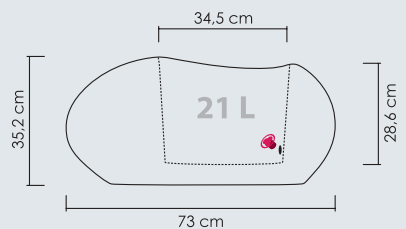
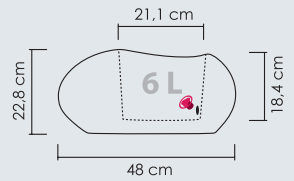

1  
**280 FLOW**®  
STONY BLACK  
SIZE 48, 73  
» PAGE 103

2  
**280 FLOW**®  
STONY GREY  
SIZE 48, 73  
» PAGE 103

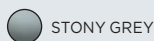
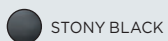

# MODERN PATIO. FEEL THE GROOVE<sup>+</sup>

Mit seiner **dickwandigen Machart**, seinen **markanten Rillen am Rand** und dem **Bewässerungseinsatz** beweist **GROOVE<sup>+</sup>**, dass Design und Pflanzenpflege perfekt zusammenpassen.

*With its **thick-walled style**, its **striking grooves on the top rim** and the **watering insert**, **GROOVE<sup>+</sup>** proves that design and plant care can be perfectly combined.*



up to  
**98%**  
recycled  
Material

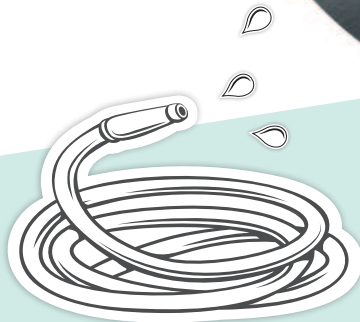

①

**266 GROOVE<sup>+</sup>**  
CARBON  
SIZE 30, 40  
» PAGE 109

②

**266 GROOVE<sup>+</sup>**  
CONCRETE  
SIZE 30, 40  
» PAGE 109



CARBON



CONCRETE



# groove<sup>+</sup>



MODERN PATIO · GROOVE<sup>+</sup>

①

②



Mit Verschluss  
With plug



BEWÄSSERUNGS-  
EINSATZ INKL.

WATERING  
INSERT INCL.

Weitere Informationen  
siehe Seite 18  
More information see  
page 18

# MODERN PATIO. PURE PURISTA<sup>+</sup>

**Schnörkellos, dickwandig, vielseitig:**  
**PURISTA<sup>+</sup>** überlässt die Bühne den Pflanzen,  
die dank des **Bewässerungseinsatzes**  
mindestens genauso gut aussehen.

**Unpretentious, thick-walled, versatile:**  
**PURISTA<sup>+</sup>** leaves the stage to the plants,  
which look at least as good thanks to the  
**water reservoir insert.**



①

**265 PURISTA<sup>+</sup>**  
**CARBON**  
SIZE 30, 40  
» PAGE 109

②

**265 PURISTA<sup>+</sup>**  
**CONCRETE**  
SIZE 30, 40  
» PAGE 109

● CARBON

● CONCRETE

# purista<sup>+</sup>



Mit Verschluss  
With plug



up to  
**98%**  
recycled  
Material

MODERN PATIO · PURISTA<sup>+</sup>

# MODERN PATIO. POLYTECH® PURISTA+

Jeden Tag einen neuen Look:  
mit **PolyTech®** zeigen wir die Vielfalt  
der Oberflächengestaltung auf unseren  
dickwandigen **Purista® Pflanzgefäßen**.

*A new look every day:  
with **PolyTech®** we offer a variety of  
stunning designs for our thick-walled  
**Purista® planters**.*



①

**265 PURISTA+**  
WHITE LINE  
SIZE 30  
» PAGE 109

②

**265 PURISTA+**  
GREY LINE  
SIZE 30  
» PAGE 109



WHITE LINE



GREY LINE



# purista<sup>+</sup>



up to  
**98%**  
recycled  
Material



1

Mit Verschluss  
With plug

1

2

BEWÄSSERUNGS-  
EINSATZ INKL.

WATERING  
INSERT INCL.



**stones**<sup>®</sup>

**3**  
YEARS  
GUARANTEE  
REDURO<sup>®</sup>

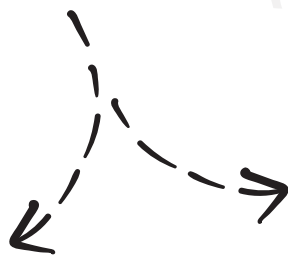

①

**286 STONES<sup>®</sup> SQUARE**  
**ANTHRACITE**

SIZE 35, 40  
» PAGE 113

Weitere Informationen  
siehe Seite 19

More information see  
page 19

● ANTHRACITE



# MODERN PATIO. IMPRESSIVE STONE-LOOK.



Unsere Serie Stones® erinnert an die mehrschichtige Struktur von Natursteinplatten. Der natürliche Stein-Look mit dem gewissen Etwas ist ein echter Blickfang.

*Our series Stones® is reminiscent of the multi-layered structure of natural stone slabs. The natural stone look with that certain something is a real eye catcher.*



MODERN PATIO · STONES®



②

**285 STONES®**  
ANTHRACITE  
SIZE 30, 35, 40, 47  
» PAGE 113

● ANTHRACITE

Passende Untersetzer siehe Seite 78 · Matching saucers see page 78





SCHEURICH | N°3 SMART WATERING

# SMART WATERING



INNOVATIV · NACHHALTIG · PRAKTISCH · FRÖHLICH  
INNOVATIVE · SUSTAINABLE · PRACTICAL · CHEERFUL

# SMART WATERING. WE CARE FOR HAPPY PLANTS.



Mit dem Bewässerungseinsatz in den Pflanzgefäßen PURISTA<sup>+</sup> und GROOVE<sup>+</sup> werden Pflanzen optimal mit Wasser versorgt, während der Überlauf im Gefäß Staunässe verhindert. Bei Bedarf - wenn des Gefäß nach drinnen umzieht - kann der Überlauf verschlossen werden.

*With the watering insert in the PURISTA<sup>+</sup> and GROOVE<sup>+</sup> planters, plants are optimally supplied with water, while the overflow in the pot prevents waterlogging. If necessary - when the pot is moved indoors - the overflow can be closed.*



up to  
**98%**  
recycled  
Material



**266 GROOVE<sup>+</sup>**  
SIZE 30, 40  
» PAGE 109

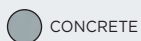

CONCRETE



CARBON



WATCH THE VIDEO!

265 PURISTA+  
SIZE \*30, 40  
» PAGE 109

- CARBON
- WHITE LINE\*
- CONCRETE
- GREY LINE\*



1. Bewässerungseinsatz im Gefäß versorgt die Pflanze optimal mit Wasser.

1. Watering insert in the container supplies the plant with water optimally.

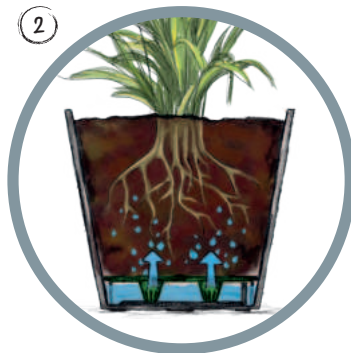

2. Die Pflanze nimmt Wasser über die Dome auf.

2. The plant absorbs water via the dome.

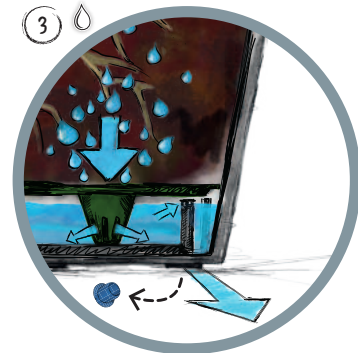

3. Der Überlauf schützt die Pflanze vor Staunässe. Überschüssiges Wasser kann abfließen. Steht die Pflanze im Wohnbereich, wird der Überlauf mit dem blauen Verschluss abgedichtet.

3. The overflow protects the plant from waterlogging. Excess water can drain off. If the plant is in the living area, the overflow is sealed with the blue stopper.

# SMART WATERING. BÖRDY® TWEETS FOR PLANTS.

Seit vielen Jahren zwitschert Bördy® von optimaler Pflanzenpflege. Als zuverlässiges Wasser Reservoir sorgt er für kleine und große Outdoor-Pflanzen - und das ganz natürlich und einfach. Mehr Infos finden Sie im Video => QR-Code einscannen!

*For many years Bördy® has been twittering about optimal plant care. As a reliable water reservoir, it provides for small and large outdoor plants - naturally and easily. You can find more information in the video => Scan QR Code!*

**BÖRDY XL IST TESTSIEGER!**  
Gesamt-Qualitätsurteil GUT  
(1,6) bei Stiftung Warentest  
(Ausgabe 06/2017)

*BÖRDY XL IS THE WINNER*  
Total quality valuation mark  
of "GOOD" (1.6) from Stiftung  
Warentest (edition 06/2017)



HOW TO  
BÖRDY®:



620 ml

29cm



Einzelverpackung mit Euroloch  
Singlebox with euro-punch

①

**110 BÖRDY® XL**  
**CHAMPAGNE PEARL**  
SIZE 29  
» PAGE 118

②

**110 BÖRDY® XL**  
**GREEN PEARL**  
SIZE 29  
» PAGE 118

③

**110 BÖRDY® XL**  
**PURPLE PEARL**  
SIZE 29  
» PAGE 118



**PFLANZE NORMAL  
GIESSEN**

WATER PLANT  
AS USUAL

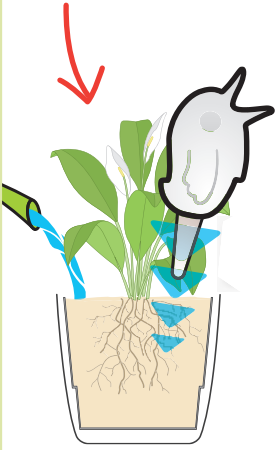

**BEWÄSSERUNG BIS ZU  
11 TAGEN (BÖRDY® XL)  
15 TAGEN (BÖRDY® XXL)  
UP TO 11 DAYS (BÖRDY® XL)  
15 DAYS (BÖRDY® XXL)  
WATERING**

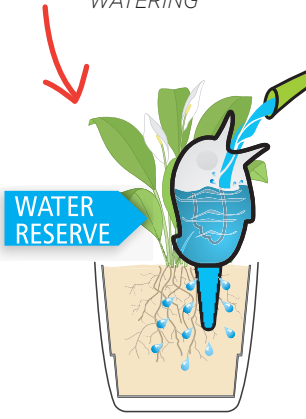

④ **110 BÖRDY® XXL  
CHAMPAGNE PEARL**  
SIZE 33  
» PAGE 118



⑤ **110 BÖRDY® XXL  
GREEN PEARL**  
SIZE 33  
» PAGE 118

SMART WATERING · BÖRDY®

# SMART WATERING.

## COPA® XXL.

**Copa® XXL macht es Bördy® einfach nach:** Er versorgt die Pflanze je nach Größe und Standort bis zu 15 Tage lang mit Gießwasser – so kann man getrost ein paar Tage länger Urlaub machen!

*Copa® XXL simply imitates Bördy®: depending on size and location, it supplies the plant with water for up to 15 days – so you can safely go on holiday a few days longer!*

HOW TO  
COPA®:



SCHÖNE FERIEEN

ENJOY YOUR  
HOLIDAYS



Einzelverpackung mit Euroloch  
Singlebox with euro-punch

**PFLANZE NORMAL  
GIESSEN**  
WATER PLANT  
AS USUAL

**BEWÄSSERUNG BIS  
ZU 15 TAGEN**  
UP TO 15 DAYS  
WATERING

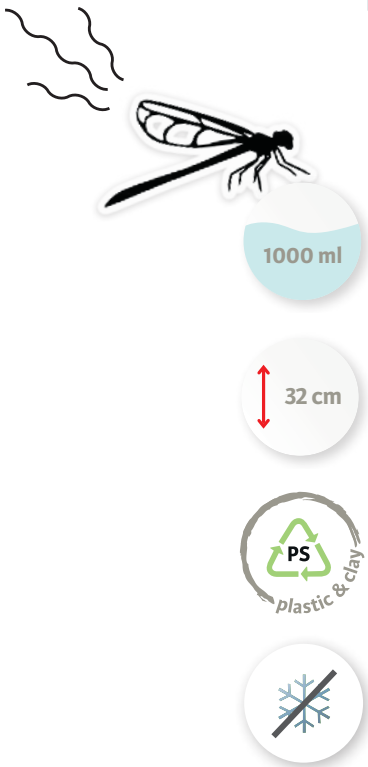
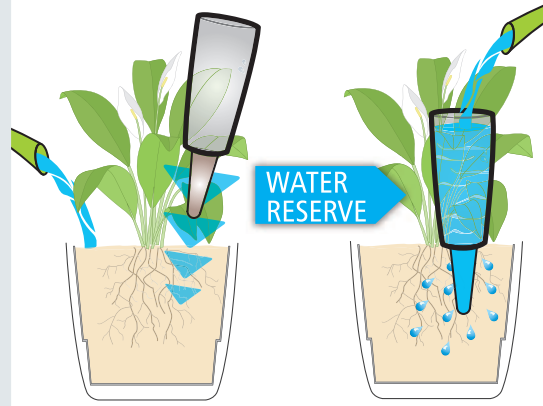

①  
**112 COPA® XXL**  
TRANSPARENT/CLEAR  
SIZE 32  
» PAGE 119

②  
**112 COPA® XXL**  
GREEN  
SIZE 32  
» PAGE 119

SMART WATERING · COPA®



# UNTERSETZER. SAUCER. ROTATION.

Auf vielfachen Kundenwunsch bieten wir Untersetzer für viele unserer Rotationsguss-Pflanzgefäße an. Ihr Vorteil: Sie passen auch zu vielen anderen Gefäßen in unserem Sortiment.

*In response to customer demands we are offering saucers for many rotation-moulded planters. Your advantage: They also fit many other planters.*

MARCELLA®



370		Schwarz-Granit	Stony Grey	Terra
Form-Nr. Shape No.	Ø cm	VE PU	Best.-Nr. Order No.	
370/26	24	6	59244	59250 59238
370/30	28	6	59245	59251 59239
370/35	33	4	59246	59252 59240
370/38	36	4	59247	59253 59241
370/43	41	4	59248	59254 59242
370/48	45	4	59249	59255 59243



## GRÖSSENTABELLE / SIZE CHART

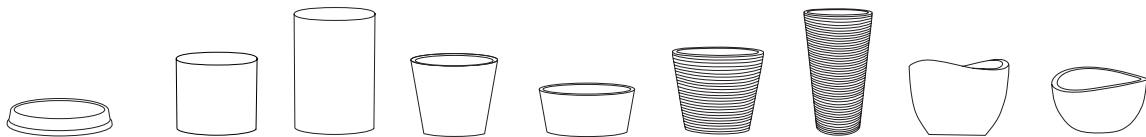









370		Riva®	Riva® High	C-Cone®	C-Cone® Bowl	Coneo®	Coneo® High	Wave Globe®	Wave Globe® Bowl
Form-Nr. Shape No.	Ø cm	130	134	238	239	242	243	250	252
370/26	24	–	–	30	–	30	55	–	–
370/30	28	–	–	–	–	–	–	30	–
370/35	33	30	40	40	–	40	70	40	–
370/38	36	–	–	–	–	–	–	–	40
370/43	41	–	–	49	40	49	–	50	–
370/48	45	40	54	–	–	–	–	60	–

Riva® 50 kein passender Unter-setzer vorhanden | no fitting saucer available



MARCELLA · SIZE CHART

GRÖSSENTABELLE / SIZE CHART

									
	370	Wave Globe® High	Linetto®	Linetto® High	Lineo®	Lineo® High	Barceo®	Barceo® Bowl	Barceo® High
Form-Nr. Shape No.	Ø cm	254	259	260	282	283	295	297	299
370/26	24	40	–	–	30	–	30	–	–
370/30	28	54	–	–	–	54	–	–	–
370/35	33	67	30	–	40	–	40	40	40
370/38	36	–	–	–	48	65	47	–	–
370/43	41	–	–	–	–	–	–	–	–
370/48	45	–	40	54	–	–	–	–	54

Weitere Untersetzer siehe Seite 106/107 + 116/117  
More saucers see page 106/107 + 116/117

# UNTERSETZER. SAUCER.

## SPRITZGUSS. INJECTION-MOULDED.

### LINDA®



331			Metallic Grey	Granite Grey	Terracotta
Form-Nr. Shape No.	Ø cm	VE PU	Best.-Nr. Order No.		
331/18	18	20	53155	—	53164
331/20	20	20	57706	58945	57704
331/24	24	20	53156	58946	53165
331/28	28	20	53157	58947	53166
331/30	30	10	57707	58948	57705
331/33	33	10	53158	—	53167
331/37	37	10	53159	58949	53168
331/44	45	10	53160	—	53169
331/54	54	10	53161	—	53170
331/64	63	10	53162	—	53171
331/78	78	10	53163	—	53172



### GRÖSSENTABELLE / SIZE CHART



331		Purista+	Groove+	Country Star®	Country Star® Bowl	Stones®	Oliver®	Jessica®
Form-Nr. Shape No.	Ø cm	265	266	270	276	285	322	340
331/18	18	—	—	—	—	—	20	20
331/20	20	—	—	25	—	—	—	—
331/24	24	—	—	30	30	30	25	—
331/28	28	30	—	35	—	35	30	30
331/30	30	—	30	40	40	40	—	—
331/33	33	40	—	—	—	—	35	35
331/37	37	—	—	48	—	47	40	40
331/44	45	—	40	—	—	—	45/50	50
331/54	54	—	—	—	—	—	60	—
331/64	63	—	—	—	—	—	70	—
331/78	78	—	—	—	—	—	80	—



**SAUCER-  
SELLER  
&  
SAUCER-  
SELLER  
SMALL**

Mehr Information  
siehe Seite 91

More information  
see page 91

**LARA®**



327		Metallic Grey		Terracotta	
Form-Nr. Shape No.	Ø cm	VE PU	Best.-Nr. Order No.	Best.-Nr. Order No.	Best.-Nr. Order No.
327/12	12	10	<b>53290</b>	<b>53298</b>	
327/16	16	10	<b>53291</b>	<b>53299</b>	
327/20	20	10	<b>53292</b>	<b>53300</b>	
327/25	25	10	<b>53293</b>	<b>53301</b>	
327/29	29	10	<b>53294</b>	<b>53302</b>	
327/35	35	10	<b>53295</b>	<b>53303</b>	
327/40	40	5	<b>53296</b>	<b>53304</b>	
327/50	48	5	<b>53297</b>	<b>53305</b>	

**GRÖSSENTABELLE  
SIZE CHART**



327		Nora®		Stones® Square	
Form-Nr. Shape No.	Ø cm	326	286	326	286
327/12	12	14	—	—	—
327/16	16	19	—	—	—
327/20	20	23	—	—	—
327/25	25	28	35	—	—
327/29	29	33	40	—	—
327/35	35	40	—	—	—
327/40	40	48	—	—	—
327/50	48	58	—	—	—



Weitere Untersetzer siehe Seite 106/107 + 116/117  
More saucers see page 106/107 + 116/117

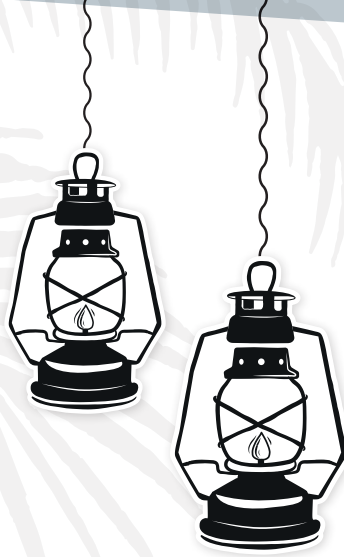

Diese Artikel sind nicht Teil unseres Standardsortiments. Je nach Größe und Farbe produzieren wir diese gerne in einer entsprechenden Mindestmenge für Sie. Sprechen Sie uns einfach an!

*These items are not part of our standard product range. We would gladly produce the requested quantity though for you in the desired size and colour if the minimum is met. Please contact us for more information!*

# AUF ANFRAGE. ON REQUEST.

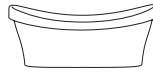

Wave Garden® 251		Wave Garden® Cubo 261		Wave Garden® Bowl 262		Wave Garden® Jardiniere 263	
Form	VE/PU	Form	VE/PU	Form	VE/PU	Form	VE/PU
251/30	6	261/30	6	262/30	6	263/50	6
251/35	6	261/40	6	262/40	6	-	-
251/41	6	261/50	4	-	-	-	-
251/48	4	-	-	-	-	-	-



Mit Verschluss  
With plug







Mit Verschluss  
With plug



**wave garden**<sup>®</sup>

Weitere on request Artikel siehe Seite 82/83  
More on request articles see page 82/83



# AUF ANFRAGE. ON REQUEST.

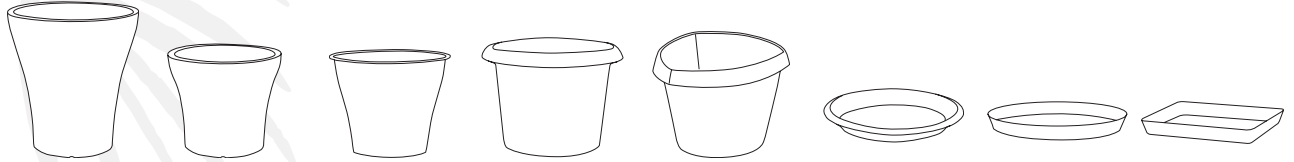

No1® Style High 264		No1® Style 268		Neo® 269		Oliver® 322		Trigon® 323		Linda® 331		Linus® 330		Lars® 332	
Form	VE/PU	Form	VE/PU	Form	VE/PU	Form	VE/PU	Form	VE/PU	Form	VE/PU	Form	VE/PU	Form	VE/PU
264/32	2	268/30	6	269/25	6	322/15	10	323/30	10	331/12	20	330/23	20	332/26	10
264/43	1	268/35	2	269/30	6	322/18	10	323/40	10	331/14	20	330/27	20	332/30	10
-	-	268/40	2	269/35	6	322/20 <sup>*)</sup>	20	323/50	5	331/16	20	330/30	10	-	-
-	-	268/48	1	269/40	6	322/25 <sup>*)</sup>	20	-	-	331/18 <sup>*)</sup>	20	330/36	10	-	-
-	-	-	-	269/48	4	322/30 <sup>*)</sup>	10	-	-	331/20 <sup>*)</sup>	20	-	-	-	-
-	-	-	-	-	-	322/35 <sup>*)</sup>	10	-	-	331/24 <sup>*)</sup>	20	-	-	-	-
-	-	-	-	-	-	322/40 <sup>*)</sup>	10	-	-	331/28 <sup>*)</sup>	20	-	-	-	-
-	-	-	-	-	-	322/45 <sup>*)</sup>	5	-	-	331/30 <sup>*)</sup>	10	-	-	-	-
-	-	-	-	-	-	322/50 <sup>*)</sup>	5	-	-	331/33 <sup>*)</sup>	10	-	-	-	-
-	-	-	-	-	-	322/60 <sup>*)</sup>	5	-	-	331/37 <sup>*)</sup>	10	-	-	-	-
-	-	-	-	-	-	322/70 <sup>*)</sup>	5	-	-	331/44 <sup>*)</sup>	10	-	-	-	-
-	-	-	-	-	-	322/80 <sup>*)</sup>	5	-	-	331/54 <sup>*)</sup>	10	-	-	-	-
-	-	-	-	-	-	-	-	-	-	331/64 <sup>*)</sup>	10	-	-	-	-
-	-	-	-	-	-	-	-	-	-	331/78 <sup>*)</sup>	10	-	-	-	-

Weitere on request Artikel siehe Seite 80/81  
und Formwerk-Katalog.  
More on request articles see page 80/81  
and Formwerk catalogue.



Gerne produzieren wir diese weiteren Artikel, je nach Größe und Farbe, in einer entsprechenden Mindestmenge für Sie. Nehmen Sie Kontakt mit uns auf!

*We would gladly produce the requested quantity though for you in the desired size and colour if the minimum is met. Please contact us for more information!*

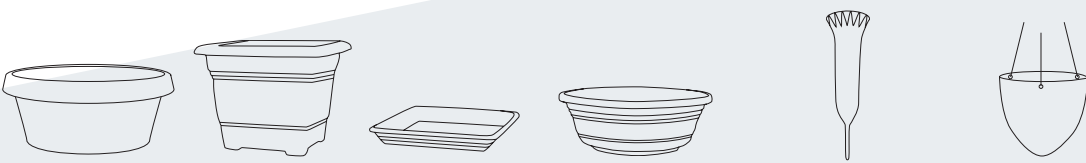

Stones® Bowl 287		Nora 326		Lara 327		Jessica 340		Grabvase/Grave vase 350			Skyhanger 209	
Form	VE/PU	Form	VE/PU	Form	VE/PU	Form	VE/PU	Form	Vol. L	VE/PU	Form	VE/PU
287/40	6	326/14 <sup>*1)</sup>	10	327/12 <sup>*1)</sup>	10	340/20 <sup>*1)</sup>	20	350/21	0,3	10	209/20	8
		326/19 <sup>*1)</sup>	10	327/16 <sup>*1)</sup>	10	340/25	20	350/26	0,6	10	-	-
		326/23 <sup>*1)</sup>	10	327/20 <sup>*1)</sup>	10	340/30 <sup>*1)</sup>	10	350/31	0,8	5	-	-
		326/28 <sup>*1)</sup>	10	327/25 <sup>*1)</sup>	10	340/35 <sup>*1)</sup>	10	350/37	1,1	5	-	-
		326/33 <sup>*1)</sup>	10	327/29 <sup>*1)</sup>	10	340/40 <sup>*1)</sup>	10	350/42	1,3	5	-	-
		326/40 <sup>*1)</sup>	10	327/35 <sup>*1)</sup>	10	340/45	10	-	-	-	-	-
		326/48 <sup>*1)</sup>	5	327/40 <sup>*1)</sup>	5	340/50 <sup>*1)</sup>	10	-	-	-	-	-
		326/58 <sup>*1)</sup>	5	327/50 <sup>*1)</sup>	5	340/60	5	-	-	-	-	-

\*1) Sortimentsartikel, siehe Bestellteil Seiten 114-117  
assortment articles, see pages 114-117

# POINT OF SALE. A REAL EYE-CATCHER.

## FOR ROTATION MOULD PRODUCTS

Mit diesem speziell für Sie entwickelten Modulkonzept erreichen Sie Ihre Kunden und steigern den Umsatz.

*With this planogram concept especially designed for you, you will reach more customers and increase your turnover.*

REGALPLAKAT  
SHELF POSTER  
20 x 80 cm



ROTATIONAL  
MOULDING



Mehr Information  
siehe Seite 17  
More information see  
page 17



SCHEURICH · POINT OF SALE



REGALSCHILD  
SHELF STICKER

90 x 50 mm

für alle Produkte | for all products

# POINT OF SALE. SUSTAINABLE HIGHLIGHTER.



## FOR MULTI-COMPONENT PRODUCTS

Dieses Modulkonzept für unser neues Produktsegment mit dickwandiger Machart und hochwertigem Oberflächeneffekt setzt starke Akzente für Ihren Umsatz und überzeugt Kundinnen und Kunden.

*This modular concept for our new product segment with thick-walled design and high-quality surface effect sets strong accents for your sales and convinces customers to purchase.*

REGALPLAKAT  
SHELF POSTER  
20 x 80 cm



**MULTI-COMPONENT  
PROCESS**



Mehr Information  
siehe Seite 18  
More information see  
page 18





SCHEURICH · POINT OF SALE



REGALSCHILD  
SHELF STICKER  
90 x 50 mm

für alle Produkte | for all products



# POINT OF SALE. OVERALL CONCEPT.

## FOR INJECTION MOULDING

Bei diesem Sortiment hochwertiger Spritzgussgefäße mit unterschiedlichsten Funktionen bleiben keine Wünsche offen. Verschiedene Formen garantieren beste Abverkaufszahlen.

*This product range of high-value injection moulded planters with various features & benefits leave no wish open. Different shapes guarantee optimal sales results.*

REGALPLAKAT  
SHELF POSTER  
20 x 80 cm



INJECTION  
MOULDING



Mehr Information  
siehe Seite 19  
More information see  
page 19





SCHEURICH · POINT OF SALE



REGALSCHILD  
SHELF STICKER  
90 x 50 mm

für viele Produkte | for many products

# POINT OF SALE. BESTSELLING PRESENTATION.

Stimmig konzipierte Warenträger und POS-Werbemittel sind der Schlüssel zu einer ansprechenden Warenpräsentation – und damit zu Ihrem Umsatzplus.

*Display stand units and POS material that harmonise to make your sales area and our products stand-out.*

PALETTENPRÄSENTATION  
PALLET PRESENTATION



PRODUKTAUFKLEBER & -ANHÄNGER  
STICKER + HANGTAGS



PALETTENPRÄSENTATION  
PALLET PRESENTATION



**SAUCER SELLER**

110 x 55 x 225 cm  
Breite x Tiefe x Höhe  
width x depth x height  
Order-No. 62663



**SAUCER-SELLER SMALL**

60x16x21 cm  
Breite x Tiefe x Höhe  
width x depth x height  
Order-No. 64220



**POP UP PYLON**  
**FÜR VIELE SERIEN**  
**FOR MANY SERIES**  
50 x 154 x 23 cm



**PALETTENPRÄSENTATION**  
**PALLET PRESENTATION**



# SOCIAL MEDIA.

Im Dialog mit der Community wächst das **Vertrauen in die Produkte der Marke Scheurich.**

*Constant dialogue with our growing community, increases **the trust in Scheurich's products and brand.***



♥ **SUSTAINABILITY**



”

**YouTube**

Mehr als 100 Filme unterstützen Ihren Abverkauf.

*More than 100 videos support your sales.*

**Scheurich**  
@Scheurich GmbH & Co. KG



**PLANTLOVER**

# FOLLOW US.

**Folgen Sie uns** und lassen Sie ein **Like** da!  
*Follow us and leave a like!*



BESUCHEN SIE UNS  
[www.scheurich.de](http://www.scheurich.de)



VISIT US  
[www.scheurich.com](http://www.scheurich.com)



# WHAT'S HAPPENING AT #SCHEURICH?



CAREER



”

Was uns als Unternehmen und Firmengruppe bewegt erfahren Sie auf LinkedIn

*Find out what moves us within the Scheurich company and the Scheurich-Group on LinkedIn*

**Scheurich**  
@Scheurich GmbH & Co. KG

## # MYPOTMYSTYLE

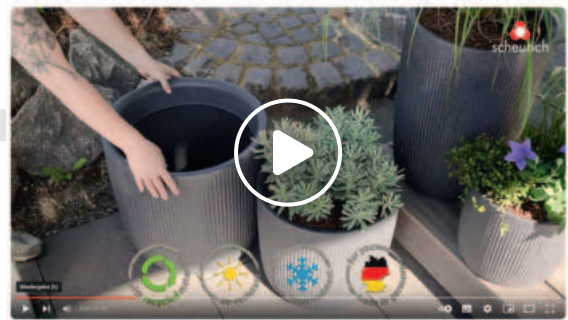

”



Unsere Neuheiten präsentieren sich quick & schick in kurzen Videos

*Our new products are presented in quick & chic short videos*

**Scheurich**  
@Scheurich GmbH & Co. KG



”



#MyPotMyStyle #outdoorplants  
#inspiration #plants #nature  
#gardening #plantsmakepeoplehappy  
#plantsofinstagram

**Scheurich**  
@Scheurich GmbH & Co. KG



## # SCHEURICH

OUTDOORNOVELTIES

# GARDURO®.

## THE POTS.



PRODUZIERT IM KUGEL-ROTATIONSGUSS-VERFAHREN.

PRODUCED USING THE BALL ROTATIONAL MOULDING PROCESS.

### 10 JAHRE GARANTIE

Echte Leichtgewichte, hochwertig verarbeitet und in verschiedenen Looks, wie Granit- oder Stein-Optik, authentisch umgesetzt: Entdecken Sie unsere **MODERN PATIO**- und **COZY COTTAGE**-Gefäße, die in punkto Größe, Farbe und Form keine Kundenwünsche offen lassen.

### 10 YEARS GUARANTEE

Really light, of high-quality craftsmanship in different looks, like granite or stone, authentically manufactured: Discover our **MODERN PATIO** and **COZY COTTAGE** planters which will satisfy all customer demands when it comes to available sizes, colours and shapes.

GARDURO®



**riva**<sup>®</sup>



# OUTDOOR COLLECTION READY TO ORDER.



**RIVA<sup>®</sup>  
STONY GREY**



**RIVA<sup>®</sup>  
SCHWARZ-GRANIT**



Form-Nr. Shape No.	L x B x H cm L x W x H cm	Vol. L Vol. L	Best.-Nr. Order No.	VE PU
130/30	29 x 29 x 24	14,0	<b>64205</b>	2
130/40	39 x 39 x 32	36,0	<b>64207</b>	2
130/50	48 x 48 x 40	68,0	<b>64209</b>	1

Form-Nr. Shape No.	L x B x H cm L x W x H cm	Vol. L Vol. L	Best.-Nr. Order No.	VE PU
130/30	29 x 29 x 24	14,0	<b>64204</b>	2
130/40	39 x 39 x 32	36,0	<b>64206</b>	2
130/50	48 x 48 x 40	68,0	<b>64208</b>	1

**RIVA<sup>®</sup> HIGH  
STONY GREY**



**RIVA<sup>®</sup> HIGH  
SCHWARZ-GRANIT**



Form-Nr. Shape No.	L x B x H cm L x W x H cm	Vol. L Vol. L	Best.-Nr. Order No.	VE PU
134/40	29 x 29 x 40	24,0	<b>64211</b>	1
134/54	39 x 39 x 53	60,0	<b>64213</b>	1

Form-Nr. Shape No.	L x B x H cm L x W x H cm	Vol. L Vol. L	Best.-Nr. Order No.	VE PU
134/40	29 x 29 x 40	24,0	<b>64210</b>	1
134/54	39 x 39 x 53	60,0	<b>64212</b>	1



RIVA<sup>®</sup>

NICE TO  
KNOW!



**C-CONE®  
STONY GREY**



Form-Nr. Shape No.	L x B x H cm L x W x H cm	Vol. L Vol. L	Best.-Nr. Order No.	VE PU
238/30	29 x 29 x 24	10,0	<b>58826</b>	2
238/40	39 x 39 x 33	26,0	<b>58827</b>	2
238/49	47 x 47 x 39	46,0	<b>58828</b>	1

**C-CONE®  
STONY BLACK**



Form-Nr. Shape No.	L x B x H cm L x W x H cm	Vol. L Vol. L	Best.-Nr. Order No.	VE PU
238/30	29 x 29 x 24	10,0	<b>58830</b>	2
238/40	39 x 39 x 33	26,0	<b>58831</b>	2
238/49	47 x 47 x 39	46,0	<b>58832</b>	1

**C-CONE® BOWL  
STONY GREY**



Form-Nr. Shape No.	L x B x H cm L x W x H cm	Vol. L Vol. L	Best.-Nr. Order No.	VE PU
239/40	39 x 39 x 18	15,0	<b>58829</b>	2

C-CONE®

**C-CONE® BOWL  
STONY BLACK**



Form-Nr. Shape No.	L x B x H cm L x W x H cm	Vol. L Vol. L	Best.-Nr. Order No.	VE PU
239/40	39 x 39 x 18	15,0	<b>58833</b>	2



**c-cone®**



**C-CUBE®  
STONY GREY**



Form-Nr. Shape No.	L x B x H cm L x W x H cm	Vol. L Vol. L	Best.-Nr. VE Order No. PU
240/30	29 x 29 x 27	18,0	<b>55822</b> 2
240/40	38 x 38 x 33	44,0	<b>55823</b> 2

**C-CUBE®  
STONY BLACK**



Form-Nr. Shape No.	L x B x H cm L x W x H cm	Vol. L Vol. L	Best.-Nr. VE Order No. PU
240/30	29 x 29 x 27	18,0	<b>55824</b> 2
240/40	38 x 38 x 33	44,0	<b>55825</b> 2

**C-CUBE® HIGH  
STONY GREY**



Form-Nr. Shape No.	L x B x H cm L x W x H cm	Vol. L Vol. L	Best.-Nr. VE Order No. PU
240/48	28 x 28 x 48	11,0	<b>59217</b> 1
240/54	38 x 38 x 54	26,0	<b>59219</b> 1
240/70	26 x 26 x 70	9,0	<b>56501</b> 1

**C-CUBE® HIGH  
STONY BLACK**



Form-Nr. Shape No.	L x B x H cm L x W x H cm	Vol. L Vol. L	Best.-Nr. VE Order No. PU
240/48	28 x 28 x 48	11,0	<b>59216</b> 1
240/54	38 x 38 x 54	26,0	<b>59218</b> 1
240/70	26 x 26 x 70	9,0	<b>56502</b> 1

**C-CUBE® LONG  
STONY GREY**



Form-Nr. Shape No.	L x B x H cm L x W x H cm	Vol. L Vol. L	Best.-Nr. VE Order No. PU
240/60	59 x 25 x 27	21,0	<b>63199</b> 1
240/80	79 x 29 x 27	35,0	<b>57842</b> 1

**C-CUBE® LONG  
STONY BLACK**



Form-Nr. Shape No.	L x B x H cm L x W x H cm	Vol. L Vol. L	Best.-Nr. VE Order No. PU
240/60	59 x 25 x 27	21,0	<b>63200</b> 1
240/80	79 x 29 x 27	35,0	<b>57843</b> 1

C-CUBE®

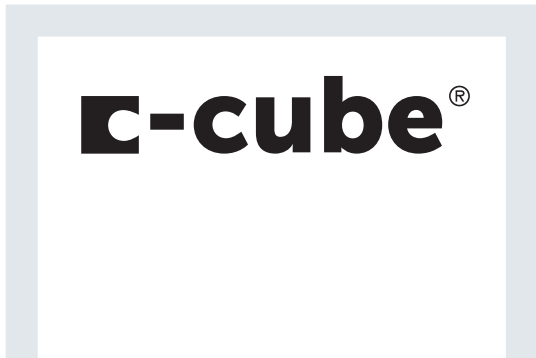

### CONEO® SCHWARZ-GRANIT



Form-Nr. Shape No.	L x B x H cm L x W x H cm	Vol. L Vol. L	Best.-Nr. Order No.	VE PU
242/30	29 x 29 x 24	10,0	<b>57546</b>	2
242/40	39 x 39 x 33	26,0	<b>57547</b>	2
242/49	47 x 47 x 39	46,0	<b>57548</b>	1

### CONEO® HIGH SCHWARZ-GRANIT



Form-Nr. Shape No.	L x B x H cm L x W x H cm	Vol. L Vol. L	Best.-Nr. Order No.	VE PU
243/55	29 x 29 x 56	9,0	<b>58462</b>	1
243/70	39 x 39 x 70	27,0	<b>58463</b>	1

CONEO®



Passende Untersetzer für  
unsere Pflanzgefäße finden  
Sie auf Seite 106/107

*Matching saucers for our  
planters can be found on  
page 106/107*



**MURETTO®  
STONY GREY**



Form-Nr. Shape No.	L x B x H cm L x W x H cm	Vol. L Vol. L	Best.-Nr. VE Order No. PU
246/30	28 x 28 x 27	18,0	<b>64455</b> 2
246/40	38 x 38 x 33	44,0	<b>64452</b> 2

**MURETTO®  
STONY BLACK**



Form-Nr. Shape No.	L x B x H cm L x W x H cm	Vol. L Vol. L	Best.-Nr. VE Order No. PU
246/30	28 x 28 x 27	18,0	<b>64456</b> 2
246/40	38 x 38 x 33	44,0	<b>64457</b> 2

**MURETTO® HIGH  
STONY GREY**



Form-Nr. Shape No.	L x B x H cm L x W x H cm	Vol. L Vol. L	Best.-Nr. VE Order No. PU
247/54	38 x 38 x 54	26,0	<b>64497</b> 1
247/60	26 x 26 x 59	9,0	<b>64498</b> 1

**MURETTO® HIGH  
STONY BLACK**



Form-Nr. Shape No.	L x B x H cm L x W x H cm	Vol. L Vol. L	Best.-Nr. VE Order No. PU
247/54	38 x 38 x 54	26,0	<b>64499</b> 1
247/60	26 x 26 x 59	9,0	<b>64500</b> 1



MURETTO®

Weitere eckige Formen siehe Seite 97  
Further square shapes see page 97



muretto®

**WAVE GLOBE®  
STONY GREY**

Form-Nr. Shape No.	L x B x H cm L x W x H cm	Vol. L Vol. L	Best.-Nr. Order No.	VE PU
250/30	30 x 30 x 22	8,0	<b>59563</b>	2
250/40	40 x 40 x 29	19,0	<b>59564</b>	2
250/50	50 x 50 x 37	37,0	<b>59565</b>	1
250/60	60 x 60 x 45	68,0	<b>59566</b>	1

**WAVE GLOBE®  
SCHWARZ-GRANIT**

Form-Nr. Shape No.	L x B x H cm L x W x H cm	Vol. L Vol. L	Best.-Nr. Order No.	VE PU
250/30	30 x 30 x 22	8,0	<b>53379</b>	2
250/40	40 x 40 x 29	19,0	<b>53380</b>	2
250/50	50 x 50 x 37	37,0	<b>53381</b>	1
250/60	60 x 60 x 45	68,0	<b>53382</b>	1

**WAVE GLOBE® BOWL  
STONY GREY**

Form-Nr. Shape No.	L x B x H cm L x W x H cm	Vol. L Vol. L	Best.-Nr. Order No.	VE PU
252/40	39 x 39 x 21	12,0	<b>59567</b>	2

WAVE GLOBE®

**WAVE GLOBE® BOWL  
SCHWARZ-GRANIT**

Form-Nr. Shape No.	L x B x H cm L x W x H cm	Vol. L Vol. L	Best.-Nr. Order No.	VE PU
252/40	39 x 39 x 21	12,0	<b>55367</b>	2

**WAVE GLOBE® JARDINIERE  
STONY GREY**

Form-Nr. Shape No.	L x B x H cm L x W x H cm	Vol. L Vol. L	Best.-Nr. Order No.	VE PU
253/58	58 x 24 x 23	15,0	<b>59568</b>	2

**WAVE GLOBE® JARDINIERE  
SCHWARZ-GRANIT**

Form-Nr. Shape No.	L x B x H cm L x W x H cm	Vol. L Vol. L	Best.-Nr. Order No.	VE PU
253/58	58 x 24 x 23	15,0	<b>55371</b>	2



**wave globe®**



**WAVE GLOBE® HIGH  
STONY GREY**



**WAVE GLOBE® HIGH  
SCHWARZ-GRANIT**



**WAVE GLOBE® CUBO  
SCHWARZ-GRANIT**



Form-Nr. Shape No.	L x B x H cm L x W x H cm	Vol. L Vol. L	Best.-Nr. VE Order No. PU
254/40	30 x 30 x 40	6,0	<b>59575</b> 1
254/54	40 x 40 x 53	16,0	<b>59576</b> 1
254/67	50 x 50 x 67	33,0	<b>59577</b> 1

Form-Nr. Shape No.	L x B x H cm L x W x H cm	Vol. L Vol. L	Best.-Nr. VE Order No. PU
254/40	30 x 30 x 40	6,0	<b>54265</b> 1
254/54	40 x 40 x 53	16,0	<b>54266</b> 1
254/67	50 x 50 x 67	33,0	<b>54267</b> 1

Form-Nr. Shape No.	L x B x H cm L x W x H cm	Vol. L Vol. L	Best.-Nr. VE Order No. PU
256/40	39 x 39 x 36	31,0	<b>55360</b> 2
256/50	50 x 50 x 44	62,0	<b>55361</b> 1



WAVE GLOBE®



**LINETTO®  
STONY GREY**

Form-Nr. Shape No.	L x B x H cm L x W x H cm	Vol. L Vol. L	Best.-Nr. Order No.	VE PU
259/30	29 x 29 x 26	14,0	<b>66653</b>	2
259/40	39 x 39 x 35	35,0	<b>66654</b>	2
259/47	47 x 47 x 43	62,0	<b>66655</b>	1

**LINETTO®  
STONY BLACK**

Form-Nr. Shape No.	L x B x H cm L x W x H cm	Vol. L Vol. L	Best.-Nr. Order No.	VE PU
259/30	29 x 29 x 26	14,0	<b>66657</b>	2
259/40	39 x 39 x 35	35,0	<b>66658</b>	2
259/47	47 x 47 x 43	62,0	<b>66659</b>	1

Neue moderne Form mit  
vertikaler Streifenstruktur.  
Weitere Informationen  
finden Sie auf Seiten 48/49

*New modern shape with  
vertical stripe structure.  
More information can be  
found on pages 48/49*

LINETTO®

**LINETTO® HIGH  
STONY GREY**

Form-Nr. Shape No.	L x B x H cm L x W x H cm	Vol. L Vol. L	Best.-Nr. Order No.	VE PU
260/54	39 x 39 x 54	50,0	<b>66656</b>	1

**LINETTO® HIGH  
STONY BLACK**



Form-Nr. Shape No.	L x B x H cm L x W x H cm	Vol. L Vol. L	Best.-Nr. Order No.	VE PU
260/54	39 x 39 x 54	50,0	<b>66660</b>	1



**Linetto®**

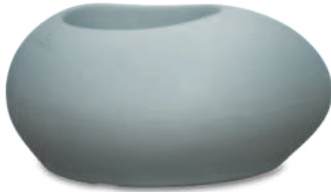

**FLOW®  
STONY GREY**



Form-Nr. Shape No.	L x B x H cm L x W x H cm	Vol. L Vol. L	Best.-Nr. Order No.	VE PU
280/48	48 x 38 x 23	6,0	<b>58892</b>	1
280/73	73 x 58 x 35	21,0	<b>58893</b>	1

**FLOW®  
STONY BLACK**



Form-Nr. Shape No.	L x B x H cm L x W x H cm	Vol. L Vol. L	Best.-Nr. Order No.	VE PU
280/48	48 x 38 x 23	6,0	<b>58890</b>	1
280/73	73 x 58 x 35	21,0	<b>58891</b>	1



**LINEO®  
SCHWARZ-GRANIT**



Form-Nr. Shape No.	L x B x H cm L x W x H cm	Vol. L Vol. L	Best.-Nr. Order No.	VE PU
282/30	29 x 29 x 24	11,0	<b>56524</b>	2
282/40	39 x 39 x 33	28,0	<b>56525</b>	2
282/48	47 x 47 x 40	50,0	<b>56526</b>	1

**LINEO® HIGH  
SCHWARZ-GRANIT**



Form-Nr. Shape No.	L x B x H cm L x W x H cm	Vol. L Vol. L	Best.-Nr. Order No.	VE PU
283/54	39 x 39 x 54	15,0	<b>57540</b>	1
283/65	47 x 47 x 65	26,0	<b>57541</b>	1



LINEO® | FLOW®



**BARCEO®**  
**STONY GREY**



Form-Nr. Shape No.	L x B x H cm L x W x H cm	Vol. L Vol. L	Best.-Nr. Order No.	VE PU
295/30	29 x 29 x 22	9,5	<b>63201</b>	2
295/40	39 x 39 x 30	28,5	<b>63203</b>	2
295/47	47 x 47 x 36	50,0	<b>63205</b>	1

**BARCEO®**  
**STONY BLACK**



Form-Nr. Shape No.	L x B x H cm L x W x H cm	Vol. L Vol. L	Best.-Nr. Order No.	VE PU
295/30	29 x 29 x 22	9,5	<b>63202</b>	2
295/40	39 x 39 x 30	28,5	<b>63204</b>	2
295/47	47 x 47 x 36	50,0	<b>63206</b>	1

**barceo®**



BARCEO®

**BARCEO® BOWL**  
**STONY GREY**



Form-Nr. Shape No.	L x B x H cm L x W x H cm	Vol. L Vol. L	Best.-Nr. Order No.	VE PU
297/40	39 x 39 x 18	14,5	<b>63207</b>	2

**BARCEO® BOWL**  
**STONY BLACK**



Form-Nr. Shape No.	L x B x H cm L x W x H cm	Vol. L Vol. L	Best.-Nr. Order No.	VE PU
297/40	39 x 39 x 18	14,5	<b>63208</b>	2





**BARCEO® JARDINIERE  
STONY GREY**



Form-Nr.	L x B x H cm	Vol. L	Best.-Nr.	VE
Shape No.	L x W x H cm	Vol. L	Order No.	PU
298/60	59 x 24 x 20	14,5	<b>63209</b>	2

**BARCEO® JARDINIERE  
STONY BLACK**



Form-Nr.	L x B x H cm	Vol. L	Best.-Nr.	VE
Shape No.	L x W x H cm	Vol. L	Order No.	PU
298/60	59 x 24 x 20	14,5	<b>63210</b>	2



**BARCEO® HIGH  
STONY GREY**



Form-Nr.	L x B x H cm	Vol. L	Best.-Nr.	VE
Shape No.	L x W x H cm	Vol. L	Order No.	PU
299/40	29 x 29 x 40	6,5	<b>63211</b>	1
299/54	39 x 39 x 54	17,0	<b>63213</b>	1

**BARCEO® HIGH  
STONY BLACK**



Form-Nr.	L x B x H cm	Vol. L	Best.-Nr.	VE
Shape No.	L x W x H cm	Vol. L	Order No.	PU
299/40	29 x 29 x 40	6,5	<b>63212</b>	1
299/54	39 x 39 x 54	17,0	<b>63214</b>	1



**MARCELLA®  
STONY GREY**

Form-Nr. Shape No.	L x B x H cm L x W x H cm	Best.-Nr. Order No.	VE PU
370/26	24 x 24 x 4	<b>59250</b>	6
370/30	28 x 28 x 4	<b>59251</b>	6
370/35	33 x 33 x 4	<b>59252</b>	4
370/38	36 x 36 x 4	<b>59253</b>	4
370/43	41 x 41 x 4	<b>59254</b>	4
370/48	45 x 45 x 4	<b>59255</b>	4



Mehr Information zu den  
Untersetzern für unsere  
Rotationsguss-Pflanzgefäße  
finden Sie auf Seite 76/77

More information about our  
saucers for many rotation-  
moulded planters can be found  
on page 76/77

**MARCELLA®  
SCHWARZ-GRANIT**



**MARCELLA®  
TERRA**



Form-Nr. Shape No.	L x B x H cm L x W x H cm	Best.-Nr. Order No.	VE PU
370/26	24 x 24 x 4	<b>59244</b>	6
370/30	28 x 28 x 4	<b>59245</b>	6
370/35	33 x 33 x 4	<b>59246</b>	4
370/38	36 x 36 x 4	<b>59247</b>	4
370/43	41 x 41 x 4	<b>59248</b>	4
370/48	45 x 45 x 4	<b>59249</b>	4

Form-Nr. Shape No.	L x B x H cm L x W x H cm	Best.-Nr. Order No.	VE PU
370/26	24 x 24 x 4	<b>59238</b>	6
370/30	28 x 28 x 4	<b>59239</b>	6
370/35	33 x 33 x 4	<b>59240</b>	4
370/38	36 x 36 x 4	<b>59241</b>	4
370/43	41 x 41 x 4	<b>59242</b>	4
370/48	45 x 45 x 4	<b>59243</b>	4

**SAUCER**



# CERTURO®.

## THE POTS.



PRODUZIERT IM MULTI-KOMPONENTEN-VERFAHREN.  
PRODUCED USING THE MULTI-COMPONENT-PROCESS.

### 8 JAHRE GARANTIE

Die Eigenschaften von CERTURO® ermöglichen die Herstellung und Gestaltung von dickwandigen Pflanzgefäßen **besonders hoher Wertigkeit** und mit **hohem Recyclinganteil**: Allesamt starke Argumente, die Ihre Kundinnen und Kunden nachhaltig überzeugen.

### 8 YEARS GUARANTEE

*The properties of CERTURO® enable the production and design of thick-walled planters of particularly **high value** and with a **high recycled content**: all strong arguments that will win over your customers in the long term.*

CERTURO®



up to  
**98%**  
recycled  
Material



**PURISTA+  
CONCRETE**



**PURISTA+  
WHITE LINE**



**PURISTA+  
GREY LINE**



Form-Nr. Shape No.	L x B x H cm L x W x H cm	Vol. L Vol. L	Best.-Nr. Order No.	VE PU
265/30	30 x 30 x 24	10,0	<b>64628</b>	2
265/40	37 x 37 x 32	21,0	<b>64629</b>	2

Form-Nr. Shape No.	L x B x H cm L x W x H cm	Vol. L Vol. L	Best.-Nr. Order No.	VE PU
265/30	30 x 30 x 24	10,0	<b>66138</b>	2

Form-Nr. Shape No.	L x B x H cm L x W x H cm	Vol. L Vol. L	Best.-Nr. Order No.	VE PU
265/30	30 x 30 x 24	10,0	<b>66140</b>	2

**purista+**



**PURISTA+  
CARBON**



**GROOVE+  
CONCRETE**



**GROOVE+  
CARBON**



Form-Nr. Shape No.	L x B x H cm L x W x H cm	Vol. L Vol. L	Best.-Nr. Order No.	VE PU
265/30	30 x 30 x 24	10,0	<b>64630</b>	2
265/40	37 x 37 x 32	21,0	<b>64631</b>	2

Form-Nr. Shape No.	L x B x H cm L x W x H cm	Vol. L Vol. L	Best.-Nr. Order No.	VE PU
266/30	29 x 29 x 26	11,0	<b>64625</b>	2
266/40	39 x 39 x 35	31,0	<b>64998</b>	2

Form-Nr. Shape No.	L x B x H cm L x W x H cm	Vol. L Vol. L	Best.-Nr. Order No.	VE PU
266/30	29 x 29 x 26	11,0	<b>64626</b>	2
266/40	39 x 39 x 35	31,0	<b>65471</b>	2



**groove+**

Weitere SMART WATERING Produkte siehe Seite 118/119  
Further SMART WATERING products see page 118/119

# REDURO®.

## THE POTS.



PRODUZIERT IM SPRITZGUSS-VERFAHREN.

PRODUCED USING THE INJECTION MOULDING PROCESS.

### 3 JAHRE GARANTIE

Leicht, vielseitig einsetzbar und zu 100 % aus Recyclingmaterial: Pflanzgefäße aus REDURO® sind beliebt, weil nachhaltig und variantenreich. Ob **MODERN PATIO** oder **COZY COTTAGE** – für jeden Geschmack sind passende Gefäße dabei.

### 3 YEARS GUARANTEE

Lightweight, versatile and made of 100% recycled material: planters made of REDURO® are popular because they are sustainable and come in many varieties. Whether **MODERN PATIO** or **COZY COTTAGE** – there are suitable planters for every taste.

REDURO®





## COUNTRY STAR® GRANITE GREY



Form-Nr. Shape No.	L x B x H cm L x W x H cm	Vol. L Vol. L	Best.-Nr. Order No.	VE PU
270/25	24 x 24 x 19	5,0	<b>58500</b>	6
270/30	29 x 29 x 22	8,5	<b>58501</b>	6
270/35	34 x 34 x 26	14,5	<b>58502</b>	6
270/40	39 x 39 x 30	21,5	<b>58503</b>	6
270/48	48 x 48 x 37	40,0	<b>58504</b>	4

## COUNTRY STAR® TERRACOTTA



Form-Nr. Shape No.	L x B x H cm L x W x H cm	Vol. L Vol. L	Best.-Nr. Order No.	VE PU
270/25	24 x 24 x 19	5,0	<b>57670</b>	6
270/30	29 x 29 x 22	8,5	<b>57671</b>	6
270/35	34 x 34 x 26	14,5	<b>57672</b>	6
270/40	39 x 39 x 30	21,5	<b>57673</b>	6
270/48	48 x 48 x 37	40,0	<b>57674</b>	4

## COUNTRY STAR® METALLIC GREY



Form-Nr. Shape No.	L x B x H cm L x W x H cm	Vol. L Vol. L	Best.-Nr. Order No.	VE PU
270/25	24 x 24 x 19	5,0	<b>57665</b>	6
270/30	29 x 29 x 22	8,5	<b>57666</b>	6
270/35	34 x 34 x 26	14,5	<b>57667</b>	6
270/40	39 x 39 x 30	21,5	<b>57668</b>	6
270/48	48 x 48 x 37	40,0	<b>57669</b>	4

Weitere COUNTRY STAR®  
Produkte finden Sie  
auf Seite 112

More COUNTRY STAR®  
products can be found  
on page 112

## COUNTRY STAR® HANGER TERRACOTTA



Form-Nr. Shape No.	L x B x H cm L x W x H cm	Vol. L Vol. L	Best.-Nr. Order No.	VE PU
271/25	25 x 25 x 19	5,0	<b>60563</b>	4
271/30	29 x 29 x 22	8,5	<b>60565</b>	4

## COUNTRY STAR® HANGER METALLIC GREY



Form-Nr. Shape No.	L x B x H cm L x W x H cm	Vol. L Vol. L	Best.-Nr. Order No.	VE PU
271/25	25 x 25 x 19	5,0	<b>60564</b>	4
271/30	29 x 29 x 22	8,5	<b>60566</b>	4



**COUNTRY STAR® BOWL  
GRANITE GREY**

Form-Nr. Shape No.	L x B x H cm L x W x H cm	Vol. L Vol. L	Best.-Nr. Order No.	VE PU
276/30	29 x 29 x 11	3,8	<b>58882</b>	5
276/40	39 x 39 x 15	9,5	<b>58883</b>	5

**COUNTRY STAR® BOWL  
TERRACOTTA**

Form-Nr. Shape No.	L x B x H cm L x W x H cm	Vol. L Vol. L	Best.-Nr. Order No.	VE PU
276/30	29 x 29 x 11	3,8	<b>58886</b>	5
276/40	39 x 39 x 15	9,5	<b>58887</b>	5

**COUNTRY STAR® BOWL  
METALLIC GREY**

Form-Nr. Shape No.	L x B x H cm L x W x H cm	Vol. L Vol. L	Best.-Nr. Order No.	VE PU
276/30	29 x 29 x 11	3,8	<b>58888</b>	5
276/40	39 x 39 x 15	9,5	<b>58889</b>	5

COUNTRY STAR®

**COUNTRY STAR® JARDINIERE  
GRANITE GREY**

Form-Nr. Shape No.	L x B x H cm L x W x H cm	Vol. L Vol. L	Best.-Nr. Order No.	VE PU
277/49	49 x 19 x 15	6,0	<b>59144</b>	4

**COUNTRY STAR® JARDINIERE  
TERRACOTTA**

Form-Nr. Shape No.	L x B x H cm L x W x H cm	Vol. L Vol. L	Best.-Nr. Order No.	VE PU
277/49	49 x 19 x 15	6,0	<b>59146</b>	4

**COUNTRY STAR® JARDINIERE  
METALLIC GREY**

Form-Nr. Shape No.	L x B x H cm L x W x H cm	Vol. L Vol. L	Best.-Nr. Order No.	VE PU
277/49	49 x 19 x 15	6,0	<b>59147</b>	4



Weitere COUNTRY STAR® Produkte siehe Seite 111  
Further COUNTRY STAR® products see page 111

**country star®**



**STONES®  
ANTHRACITE**



**STONES® SQUARE  
ANTHRACITE**



Form-Nr. Shape No.	L x B x H cm L x W x H cm	Vol. L Vol. L	Best.-Nr. Order No.	VE PU
285/30	29 x 29 x 22	7,0	<b>63217</b>	6
285/35	34 x 34 x 26	15,0	<b>63220</b>	6
285/40	39 x 39 x 30	18,0	<b>63223</b>	6
285/47	47 x 47 x 36	33,0	<b>63226</b>	4

Form-Nr. Shape No.	L x B x H cm L x W x H cm	Vol. L Vol. L	Best.-Nr. Order No.	VE PU
286/35	34 x 34 x 28	16,0	<b>63229</b>	6
286/40	39 x 39 x 32	24,0	<b>63232</b>	6



STONES®



**OLIVER®  
METALLIC GREY**

**OLIVER®  
TERRACOTTA**

Weitere Produktvarianten  
siehe Seite 82/83

Further product variants  
see page 82/83

OLIVER, NORA  
UND JESSICA:



Mehr Information zu den  
passendenden Untersetzern für  
unsere Pflanzgefäße finden Sie  
auf Seite 76 - 79

More information about saucers  
for our planters can be found  
on page 76 - 79

**NORA®  
METALLIC GREY**

**NORA®  
TERRACOTTA**

Form-Nr. Shape No.	L x B x H cm L x W x H cm	Vol. L Vol. L	Best.-Nr. VE Order No. PU
322/20	20 x 20 x 14	2,7	<b>53087</b> 20
322/25	26 x 26 x 18	4,5	<b>53088</b> 20
322/30	30 x 30 x 21	8,3	<b>53089</b> 10
322/35	35 x 35 x 25	11,7	<b>53090</b> 10
322/40	40 x 40 x 28	19,3	<b>53091</b> 10
322/45	46 x 46 x 32	27,7	<b>53092</b> 5
322/50	49 x 49 x 35	37,5	<b>53093</b> 5
322/60	59 x 59 x 42	66,3	<b>53094</b> 5
322/70	70 x 70 x 49	104,5	<b>53095</b> 5
322/80	80 x 80 x 56	151,0	<b>53096</b> 5

Form-Nr. Shape No.	L x B x H cm L x W x H cm	Vol. L Vol. L	Best.-Nr. VE Order No. PU
322/20	20 x 20 x 14	2,7	<b>53098</b> 20
322/25	26 x 26 x 18	4,5	<b>53099</b> 20
322/30	30 x 30 x 21	8,3	<b>53100</b> 10
322/35	35 x 35 x 25	11,7	<b>53101</b> 10
322/40	40 x 40 x 28	19,3	<b>53102</b> 10
322/45	46 x 46 x 32	27,7	<b>53103</b> 5
322/50	49 x 49 x 35	37,5	<b>53104</b> 5
322/60	59 x 59 x 42	66,3	<b>53105</b> 5
322/70	70 x 70 x 49	104,5	<b>53106</b> 5
322/80	80 x 80 x 56	151,0	<b>53107</b> 5

Form-Nr. Shape No.	L x B x H cm L x W x H cm	Vol. L Vol. L	Best.-Nr. VE Order No. PU
326/14	14 x 14 x 11	1,1	<b>53237</b> 10
326/19	19 x 19 x 15	2,7	<b>53238</b> 10
326/23	23 x 23 x 18	6,8	<b>53239</b> 10
326/28	27,5 x 27,5 x 22	8,7	<b>53240</b> 10
326/33	33 x 33 x 26	14,4	<b>53241</b> 10
326/40	39 x 39 x 32	25,4	<b>53242</b> 10
326/48	48 x 48 x 38	45,5	<b>53243</b> 5
326/58	57 x 57 x 43	76,5	<b>53244</b> 5

Form-Nr. Shape No.	L x B x H cm L x W x H cm	Vol. L Vol. L	Best.-Nr. VE Order No. PU
326/14	14 x 14 x 11	1,1	<b>53246</b> 10
326/19	19 x 19 x 15	2,7	<b>53247</b> 10
326/23	23 x 23 x 18	6,8	<b>53248</b> 10
326/28	27,5 x 27,5 x 22	8,7	<b>53249</b> 10
326/33	33 x 33 x 26	14,4	<b>53250</b> 10
326/40	39 x 39 x 32	25,4	<b>53251</b> 10
326/48	48 x 48 x 38	45,5	<b>53252</b> 5
326/58	57 x 57 x 43	76,5	<b>53253</b> 5

Passende Untersetzter siehe Seite 116/117  
Matching saucers see page 116/117

**JESSICA®  
METALLIC GREY**



**JESSICA®  
TERRACOTTA**



**PERFECT FOR  
CONTAINER  
GARDENING**

Form-Nr. Shape No.	L x B x H cm L x W x H cm	Vol. L Vol. L	Best.-Nr. Order No.	VE PU
340/20	20 x 20 x 7	1,2	<b>53206</b>	20
340/30	30 x 30 x 11	4,9	<b>53208</b>	10
340/35	35 x 35 x 13	5,0	<b>53209</b>	10
340/40	40 x 40 x 14	10,1	<b>53210</b>	10
340/50	49 x 49 x 18	15,5	<b>53212</b>	10

Form-Nr. Shape No.	L x B x H cm L x W x H cm	Vol. L Vol. L	Best.-Nr. Order No.	VE PU
340/20	20 x 20 x 7	1,2	<b>53214</b>	20
340/30	30 x 30 x 11	4,9	<b>53216</b>	10
340/35	35 x 35 x 13	5,0	<b>53217</b>	10
340/40	40 x 40 x 14	10,1	<b>53218</b>	10
340/50	49 x 49 x 18	15,5	<b>53220</b>	10



JESSICA®

**LARA®  
METALLIC GREY**



**LARA®  
TERRACOTTA**



Form-Nr. Shape No.	L x B x H cm L x W x H cm	Best.-Nr. Order No.	VE PU	Form-Nr. Shape No.	L x B x H cm L x W x H cm	Best.-Nr. Order No.	VE PU
327/12	12 x 12 x 1	<b>53290</b>	10	327/12	12 x 12 x 1	<b>53298</b>	10
327/16	16 x 16 x 2	<b>53291</b>	10	327/16	16 x 16 x 2	<b>53299</b>	10
327/20	20 x 20 x 3	<b>53292</b>	10	327/20	20 x 20 x 3	<b>53300</b>	10
327/25	25 x 25 x 4	<b>53293</b>	10	327/25	25 x 25 x 4	<b>53301</b>	10
327/29	29 x 29 x 4	<b>53294</b>	10	327/29	29 x 29 x 4	<b>53302</b>	10
327/35	35 x 35 x 5	<b>53295</b>	10	327/35	35 x 35 x 5	<b>53303</b>	10
327/40	40 x 40 x 5	<b>53296</b>	5	327/40	40 x 40 x 5	<b>53304</b>	5
327/50	48 x 48 x 7	<b>53297</b>	5	327/50	48 x 48 x 7	<b>53305</b>	5



LARA®



**SAUCER**

**LINDA®  
METALLIC GREY**



**LINDA®  
GRANITE GREY**



**LINDA®  
TERRACOTTA**



Form-Nr. Shape No.	L x B x H cm L x W x H cm	Best.-Nr. Order No.	VE PU
331/18	18 x 18 x 3	<b>53155</b>	20
331/20	20 x 20 x 3	<b>57706</b>	20
331/24	24 x 24 x 4	<b>53156</b>	20
331/28	28 x 28 x 4	<b>53157</b>	20
331/30	30 x 30 x 4	<b>57707</b>	10
331/33	33 x 33 x 5	<b>53158</b>	10
331/37	37 x 37 x 5	<b>53159</b>	10
331/44	45 x 45 x 6	<b>53160</b>	10
331/54	54 x 54 x 8	<b>53161</b>	10
331/64	63 x 63 x 9	<b>53162</b>	10
331/78	78 x 78 x 12	<b>53163</b>	10

Form-Nr. Shape No.	L x B x H cm L x W x H cm	Best.-Nr. Order No.	VE PU
331/20	20 x 20 x 3	<b>58945</b>	20
331/24	24 x 24 x 4	<b>58946</b>	20
331/28	28 x 28 x 4	<b>58947</b>	20
331/30	30 x 30 x 4	<b>58948</b>	10
331/37	37 x 37 x 5	<b>58949</b>	10

Form-Nr. Shape No.	L x B x H cm L x W x H cm	Best.-Nr. Order No.	VE PU
331/18	18 x 18 x 3	<b>53164</b>	20
331/20	20 x 20 x 3	<b>57704</b>	20
331/24	24 x 24 x 4	<b>53165</b>	20
331/28	28 x 28 x 4	<b>53166</b>	20
331/30	30 x 30 x 4	<b>57705</b>	10
331/33	33 x 33 x 5	<b>53167</b>	10
331/37	37 x 37 x 5	<b>53168</b>	10
331/44	45 x 45 x 6	<b>53169</b>	10
331/54	54 x 54 x 8	<b>53170</b>	10
331/64	63 x 63 x 9	<b>53171</b>	10
331/78	78 x 78 x 12	<b>53172</b>	10



Weitere Produktvarianten siehe Seite 82/83  
Further product variants see page 82/83

**BÖRDY® XL  
GREEN PEARL**



Form-Nr.	L x B x H cm	Vol. L	Best.-Nr.	VE
Shape No.	L x W x H cm	Vol. L	Order No.	PU
110/29	8 x 5 x 29	0,6	52886	1

**BÖRDY® XL  
PURPLE PEARL**



Form-Nr.	L x B x H cm	Vol. L	Best.-Nr.	VE
Shape No.	L x W x H cm	Vol. L	Order No.	PU
110/29	8 x 5 x 29	0,6	52885	1

**BÖRDY® XL  
CHAMPAGNE PEARL**



Form-Nr.	L x B x H cm	Vol. L	Best.-Nr.	VE
Shape No.	L x W x H cm	Vol. L	Order No.	PU
110/29	8 x 5 x 29	0,6	52888	1



**SMART  
WATERING.**

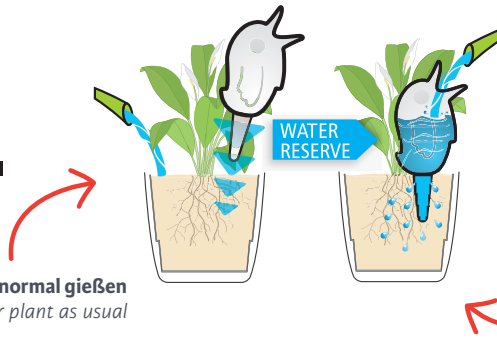

BÖRDY®

**BÖRDY® XXL  
GREEN PEARL**



Form-Nr.	L x B x H cm	Vol. L	Best.-Nr.	VE
Shape No.	L x W x H cm	Vol. L	Order No.	PU
110/33	14 x 11 x 33	1,0	58861	1

**BÖRDY® XXL  
CHAMPAGNE PEARL**



Form-Nr.	L x B x H cm	Vol. L	Best.-Nr.	VE
Shape No.	L x W x H cm	Vol. L	Order No.	PU
110/33	14 x 11 x 33	1,0	58860	1

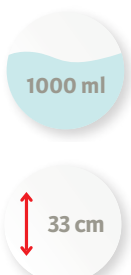

**HOW TO  
BÖRDY**



**COPA® XXL GREEN**



**COPA® XXL TRANSPARENT/CLEAR**



Form-Nr.	L x B x H cm	Vol. L	Best.-Nr.	VE
Shape No.	L x W x H cm	Vol. L	Order No.	PU
112/32	10 x 10 x 32	1,0	<b>58869</b>	1

Form-Nr.	L x B x H cm	Vol. L	Best.-Nr.	VE
Shape No.	L x W x H cm	Vol. L	Order No.	PU
112/32	10 x 10 x 32	1,0	<b>58870</b>	1

Weitere SMART WATERING  
Produkte siehe Seite 109

Further SMART WATERING  
products see page 109

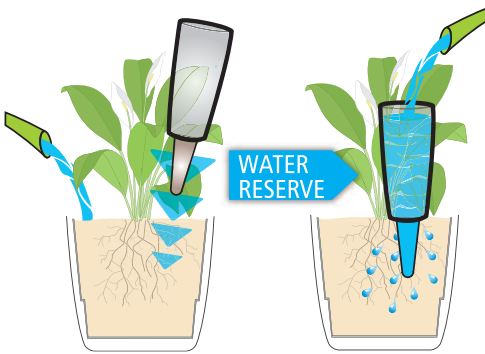

**Pflanze normal gießen**  
Water plant as usual

**Bewässerung bis zu 15 Tagen**  
Up to 15 Days watering

HOW TO  
COPA





## PRODUKTEIGENSCHAFTEN | PRODUCT DETAILS



**Passgenauer Verschluss:**  
Einsatz auch Indoor möglich  
*Precisely fitting plug:  
suitable also for indoor use*



**Keine Bodenlöcher:**  
Einsatz auch Indoor möglich  
*No bottom holes:  
suitable also for indoor use*



**Passgenauer Verschluss innen:**  
Einsatz auch Indoor möglich  
*Precisely fitting plug inside:  
suitable also for indoor use*



**Wasserablauf und -reservoir**  
*Water drain and reservoir*



**Mit Bodenlöchern: vermeiden Staunässe**  
*With bottom holes: avoids waterlogging*



**Bewässerungseinsatz im Gefäß versorgt die Pflanze optimal mit Wasser**  
*Water reservoir insert optimally feeds the plants roots with water*



## MATERIAL | MATERIAL



**Kunststoff Polyethylen**  
*Polyethylene*



**Metall-Kette 40 cm**  
*Metal chain 40 cm*



**Kunststoff Polypropylen**  
*Polypropylene*



**aus 100 % recyceltem Material hergestellt**  
*made of 100% recycled material*



**Kunststoff Polystyrol**  
*Polystyrene*



**mit recyceltem Material hergestellt**  
*made with recycled material*



**Kunststoff Polystyrol + Ton**  
*Polystyrene + Clay*



**vollständig recyclingfähig**  
*fully recyclable*

## MARKENQUALITÄT | TRUSTED BRAND



**Hergestellt in Deutschland**  
*Made in Germany*



**Material GARDURO® mit 10 Jahren Garantie**  
*Material GARDURO with 10 years guarantee*



**frostfest**  
*frost-resistant*



**Material CERTURO® mit 8 Jahren Garantie**  
*Material REDURO with 8 years guarantee*



**UV-beständig**  
*UV-resistant*



**Material REDURO® mit 3 Jahren Garantie**  
*Material REDURO with 3 years guarantee*



# LEGENDE

## KEY

- 1 STONES®  
2 ANTHRACITE



3	4	5	6	7
Form-Nr. Shape No.	L x B x H cm L x W x H cm	Vol. L Vol. L	Best.-Nr. Order No.	VE PU
285/30	29 x 29 x 22	7,0	63217	6
285/35	34 x 34 x 26	15,0	63220	6
285/40	39 x 39 x 30	18,0	63223	6
285/47	47 x 47 x 36	33,0	63226	4

- 1 **Konzept** · Theme  
2 **Dekorbezeichnung** · Finish/decoration  
3 **Form-Nr.** · Shape No.  
4 **Maße in cm** · Measurements in cm

Pflanzgefäße, Hochgefäße, Pflanzschalen, Jardinieren, Untersetzer, Hängeampeln (ohne Aufhängung), BÖRDY, COPA (inkl. Tonkegel)

Planter, Planter high, Bowls, Jardiniers, Saucer, Hangers (without suspension), BÖRDY, COPA (incl. clay cone)

**Länge x Breite in cm aussen**  
Lenght x width in cm outside

**Höhe in cm aussen an höchster Stelle**  
Height in cm outside at highest point

- 5 **Volumen in Liter** · Volume in Litres

Pflanzvolumen: Pflanzgefäße, Hochgefäße, Pflanzschalen, Jardinieren, Hängeampeln

Plant volume: Planters, Planters high, Bowls, Jardiniers, Hangers

**Wasser-Füllvolumen** · Water filling volume:  
BÖRDY, COPA

- 6 Best.-Nr. · Order No.  
7 Verkaufseinheit in Stück · Pack Unit in pieces

## ABMESSUNGEN/FÜLLMENGE | DIMENSIONS/VOLUME

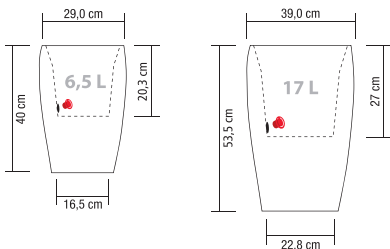

### Maße in cm · Measurements in cm

Länge x Breite x Höhe in cm · Lenght x width x height in cm

Pflanzgefäße, Hochgefäße, Pflanzschalen, Jardinieren, Untersetzer, Hängeampeln (ohne Aufhängung), BÖRDY, COPA (inkl. Tonkegel)

Planter, Planter high, Bowls, Jardiniers, Saucer, Hangers (without suspension), BÖRDY, COPA (incl. clay cone)



**Höhe in cm**  
Height in cm



**Füllmenge in ml**  
Capacity in ml

### Bildquellen:

Bildcredits Titel: Camilla Isaksson/living4media, Seite 22/23: living4media

Image credits cover: Camilla Isaksson/living4media, page 22/23: living4media



# INDOOR RANGE

Wenn Sie **nicht nur Outdoor-Produkte** suchen, schauen Sie doch einfach in unseren **aktuellen Indoor-Katalog**.

*If you are **not only looking for outdoor products** take a look at **our indoor catalogue**.*



# MEMBER OF SCHEURICH-GROUP.



Als Mitglied der **Scheurich-Group** bieten wir Ihnen maximale Sortimentskompetenz aus drei Unternehmen. Profitieren Sie von den abverkaufsstarken Konzepten zweier etablierter Marken: **Scheurich und SK.**

*As a member of the **Scheurich-Group**, we offer you maximum product competence from three companies. Benefit from the strong selling concepts of two established brands: **Scheurich and SK.***

Scheurich-Group 

 scheurich

formwerk

 SK  
SOENDBENKERAMIK



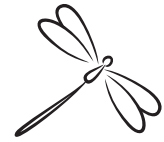

**SCHEURICH GMBH & CO. KG**  
Member of Scheurich-Group

Gottlieb-Wagner-Str. 2  
63924 Kleinheubach/Main  
Germany

Phone +49 9371 507-0  
Fax +49 9371 507-101  
info@scheurich-group.de

[www.scheurich.de](http://www.scheurich.de)

**FOLLOW US:**

